

Aeronautical English : Index

- File 01 : Aircraft Types
- File 02 : Aircraft General Structure
- File 03 : Wing Structure
- File 04 : Tail Unit Structure
- File 05 : Fuselage Structure
- File 06 : Landing Gear
- File 07 : Engines
- File 08 : Inside the Cockpit
- File 09 : Aerodynamics
- File 10 : Flight Mechanics
- File 11: Airport Infrastructure
- File 12: Air Navigation
- File 13: Meteorology
- Aeronautical English Vocabulary

Aeronautical English File 01: Aircraft types

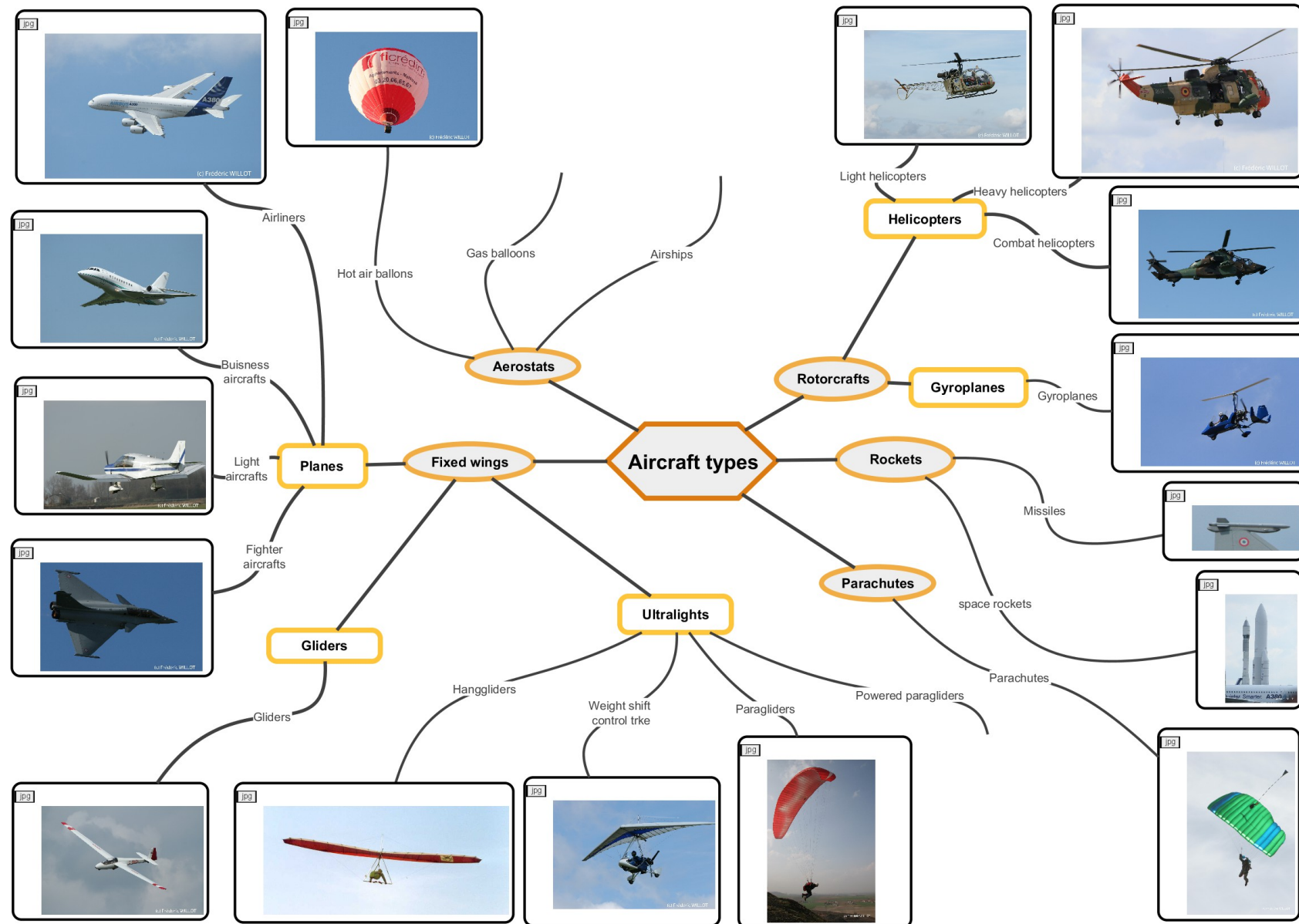

Aeronautical English File 02: Aircraft structure

(c) Frédéric WILLOT

General Structure of an Airplane

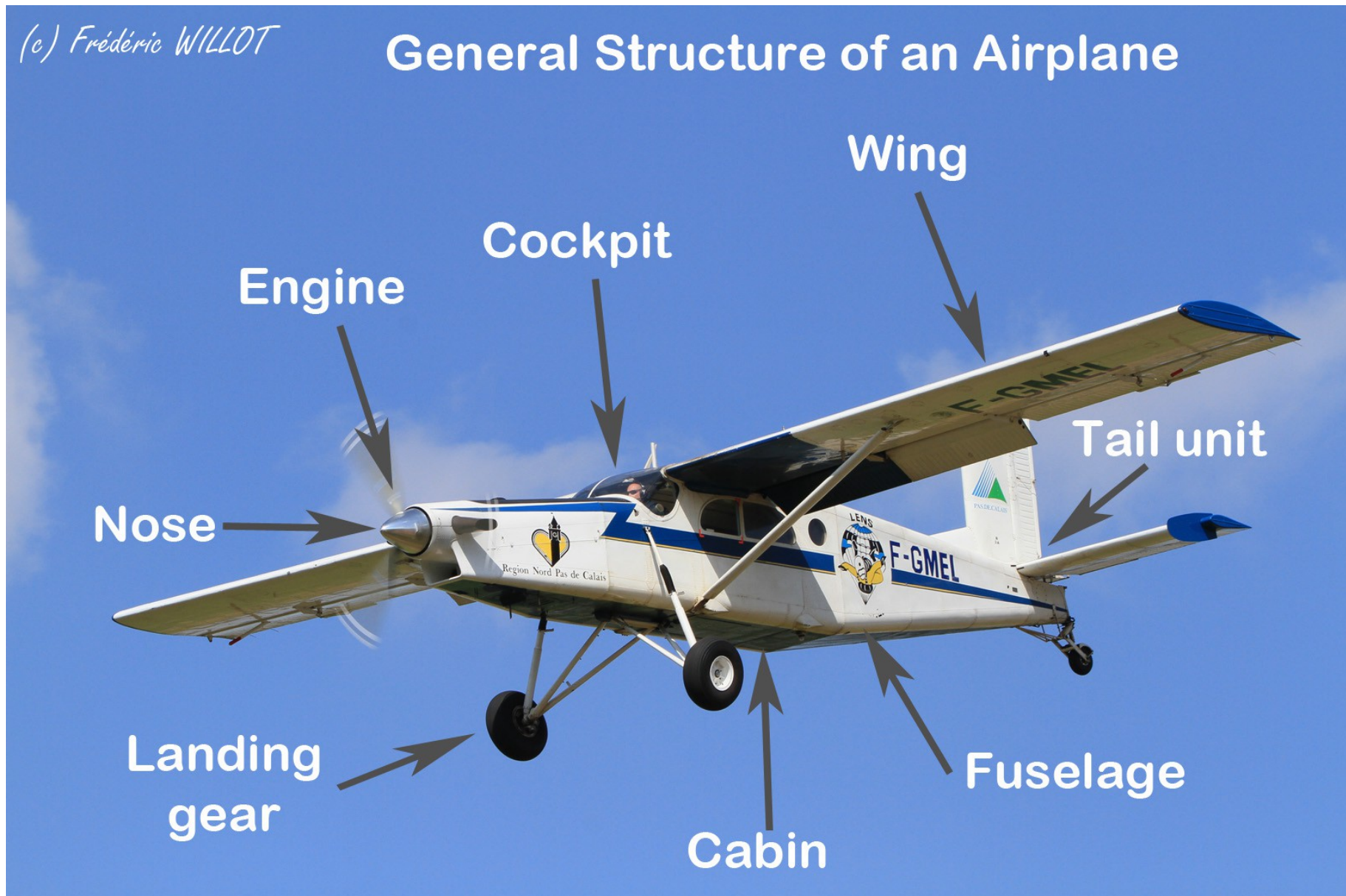

General Structure of a helicopter



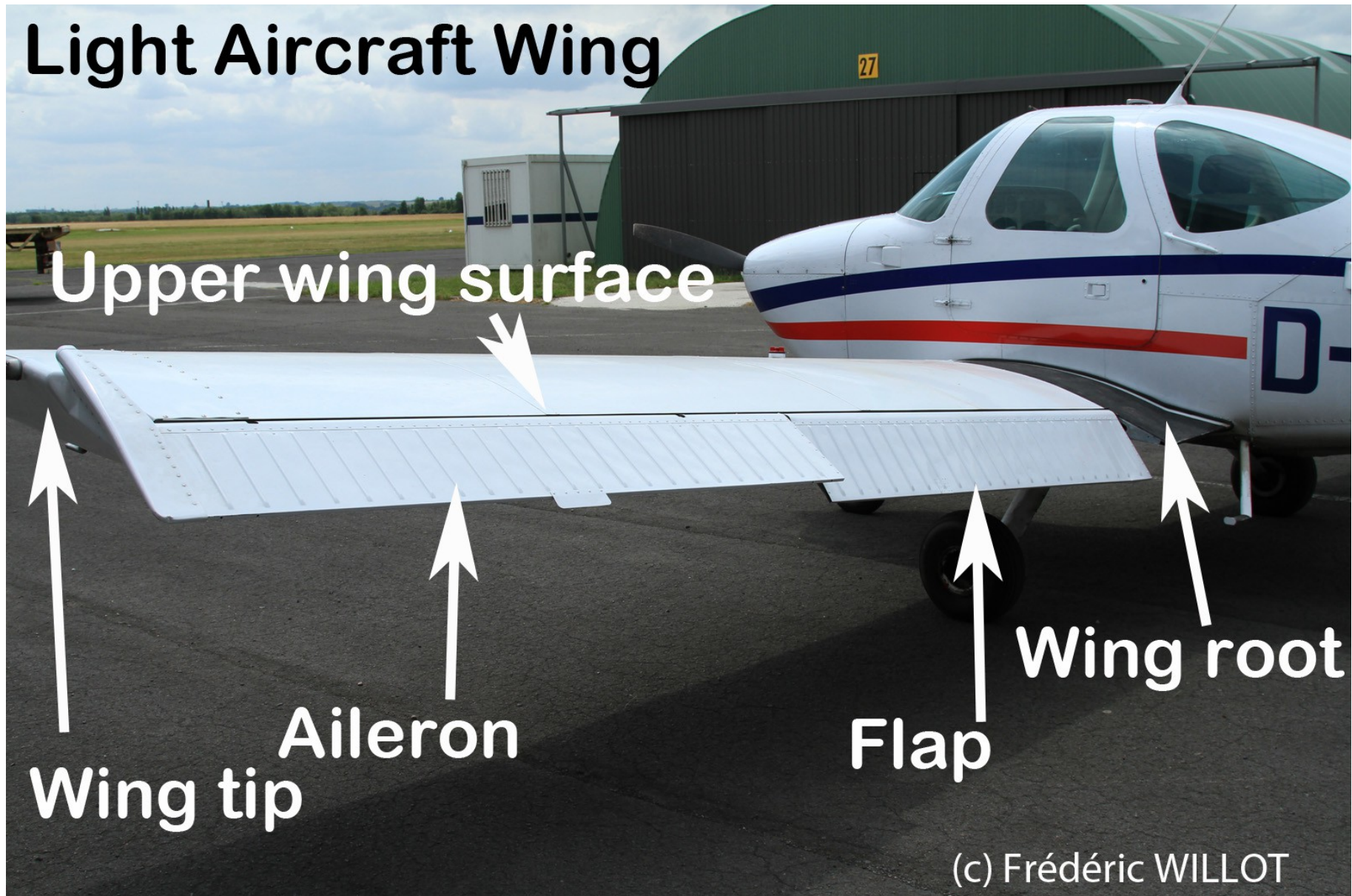

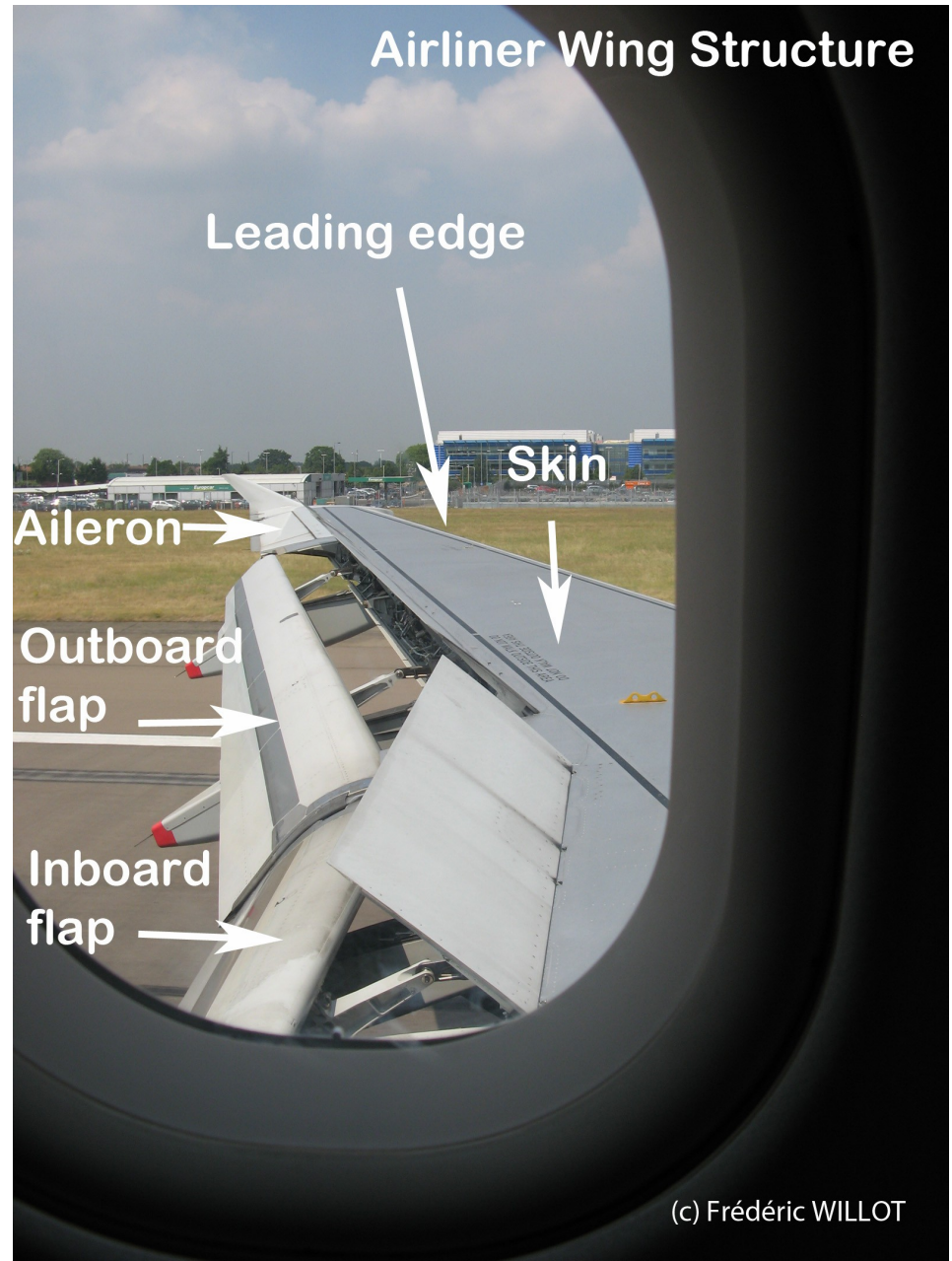
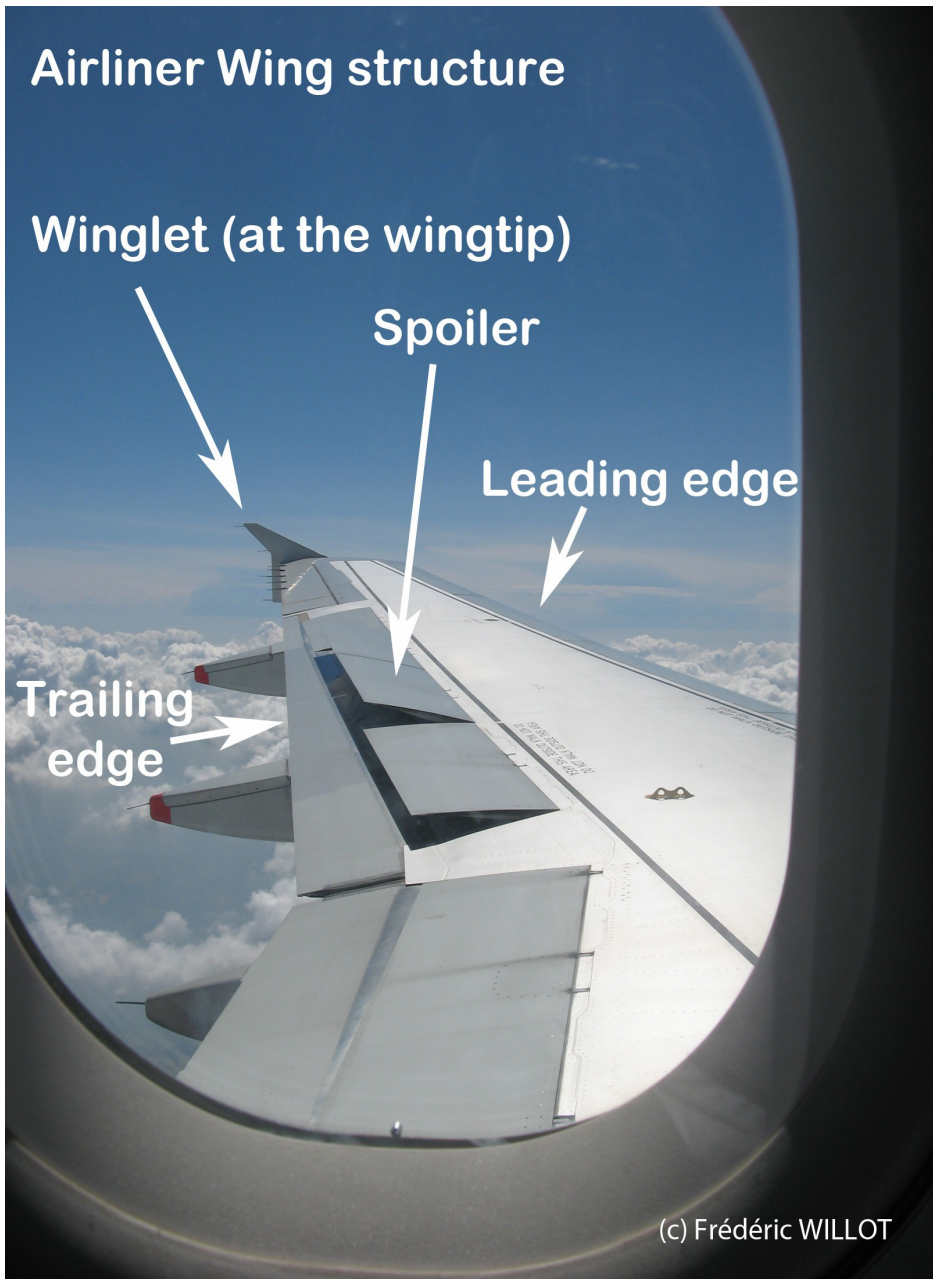

Inner Structure of a Wing

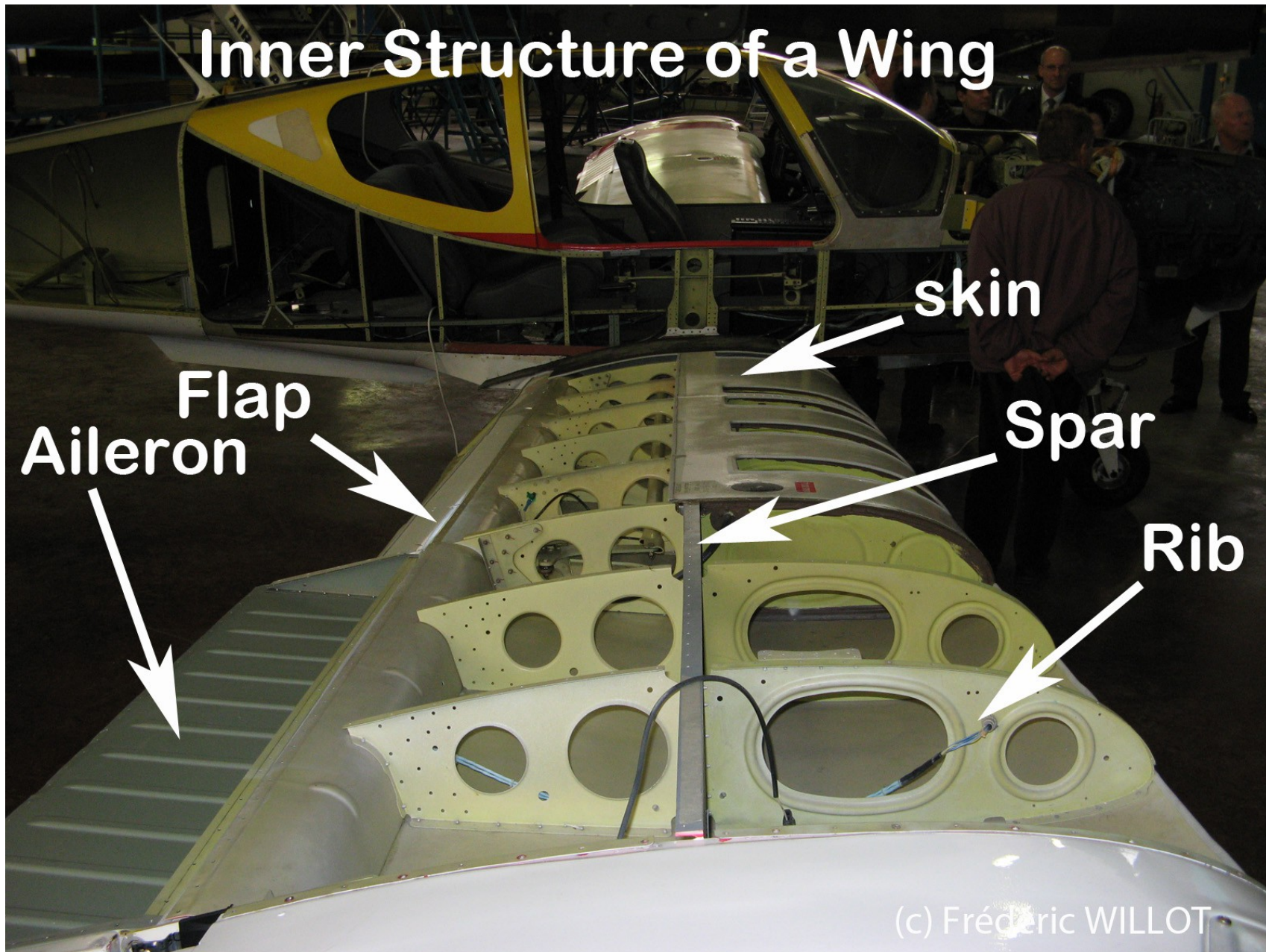

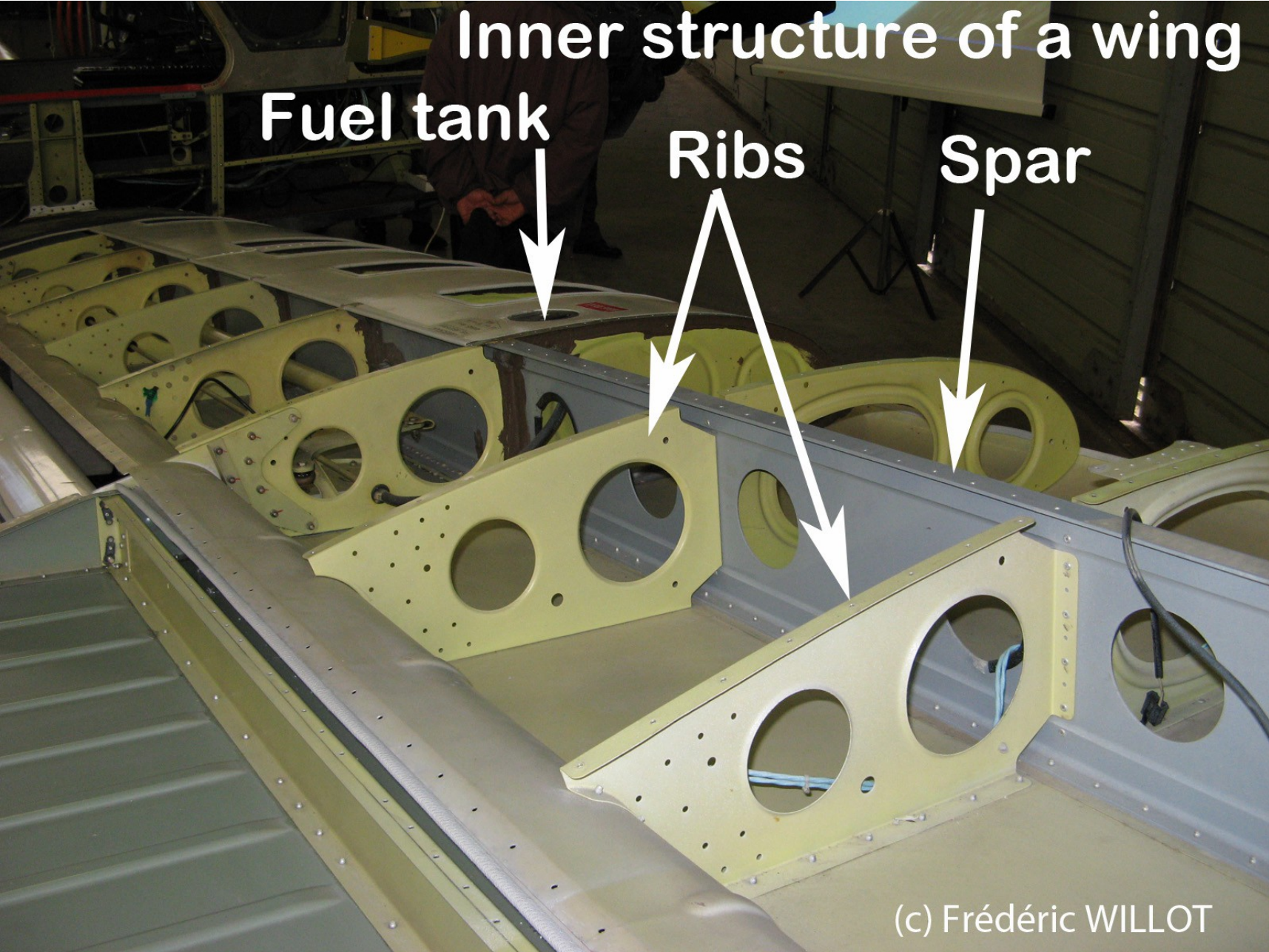

Wings position:



(c) Frédéric WILLOT

Low wing



(c) Frédéric WILLOT

Mid wing



(c) Frédéric WILLOT

High wing



(c) Frédéric WILLOT

Shoulder wing

Wings angle:



(c) Frédéric WILLOT

Dihedral wings



(c) Frédéric WILLOT

Anhedral wings



(c) Frédéric WILLOT

inverted gull wing

Wing shapes:



Straight wings

(c) Frédéric WILLOT



Tapered wings

(c) Frédéric WILLOT



Swept wings

(c) Frédéric WILLOT



Elliptic wings

(c) Frédéric WILLOT



(c) Frédéric WILLOT

Delta wings



(c) Frédéric WILLOT

Cropped delta wings and canard



(c) Frédéric WILLOT

Biplane



(c) Frédéric WILLOT

Triplane

High lift devices:



(c) Frédéric WILLOT

Plain flap



(c) Frédéric WILLOT

Fowler flap



(c) Frédéric WILLOT

(double, triple) Slotted flaps



(c) Frédéric WILLOT

Leading edge slots



(c) Frédéric WILLOT

Leading edge slats



(c) Frédéric WILLOT

Saw tooth

Aeronautical English File 04: Tail Unit

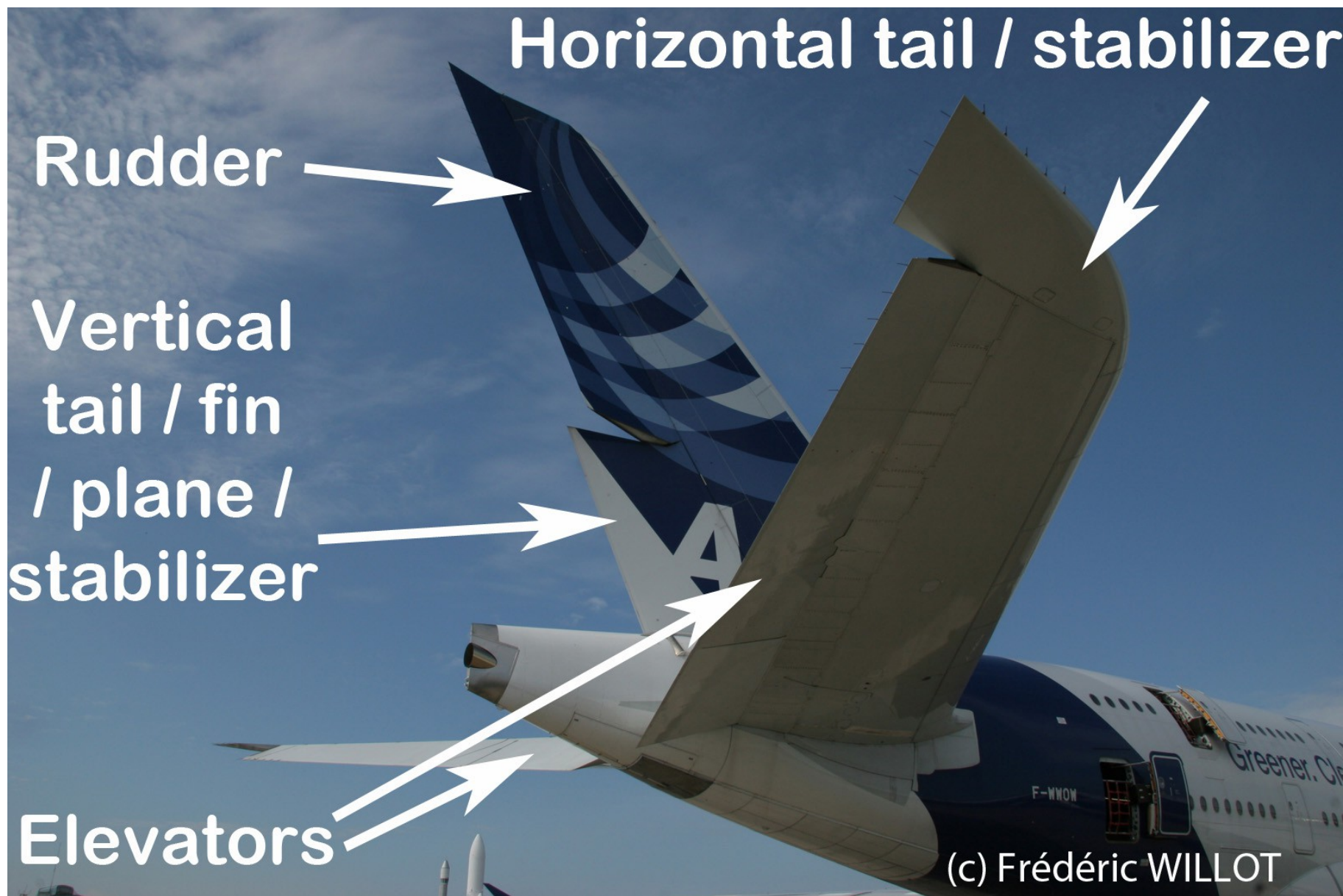

Tail unit structure:

Vertical fin structure:

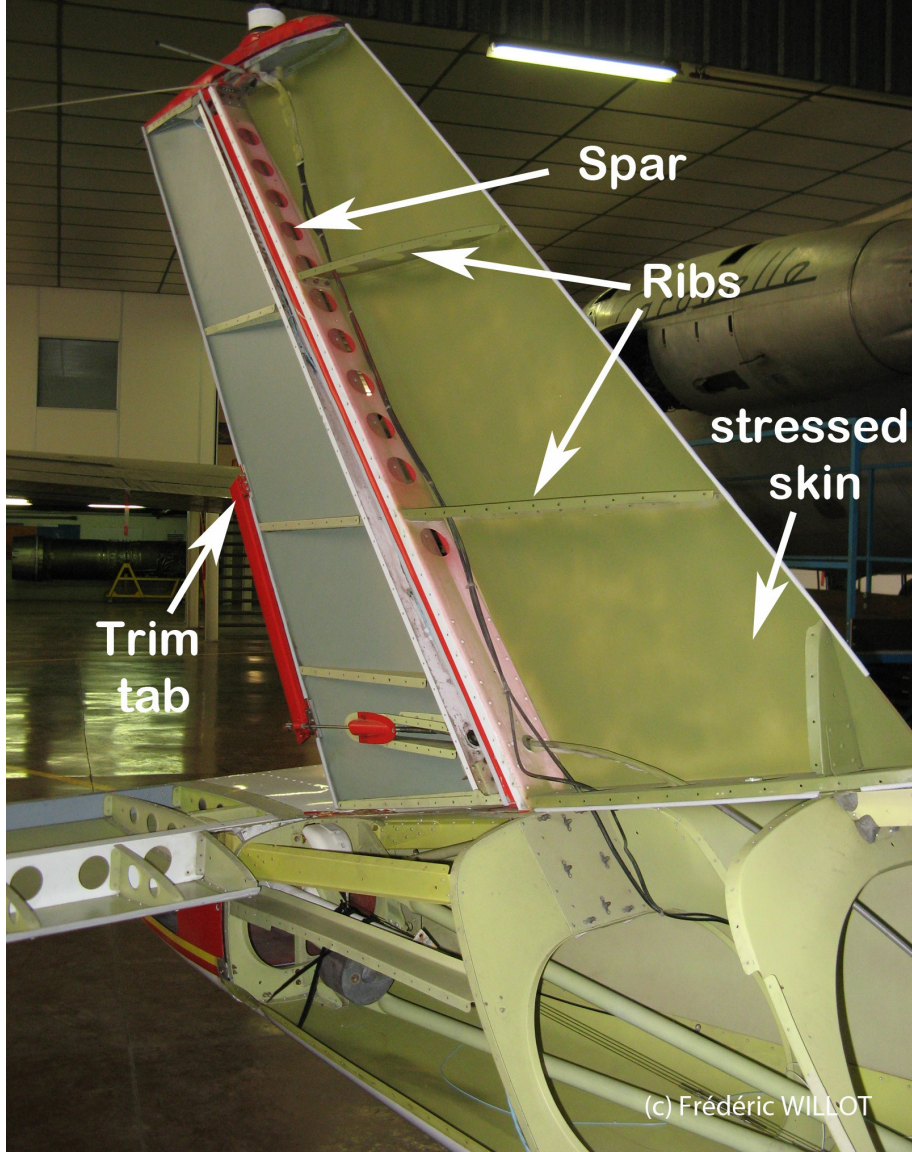

Horizontal Tail Structure:

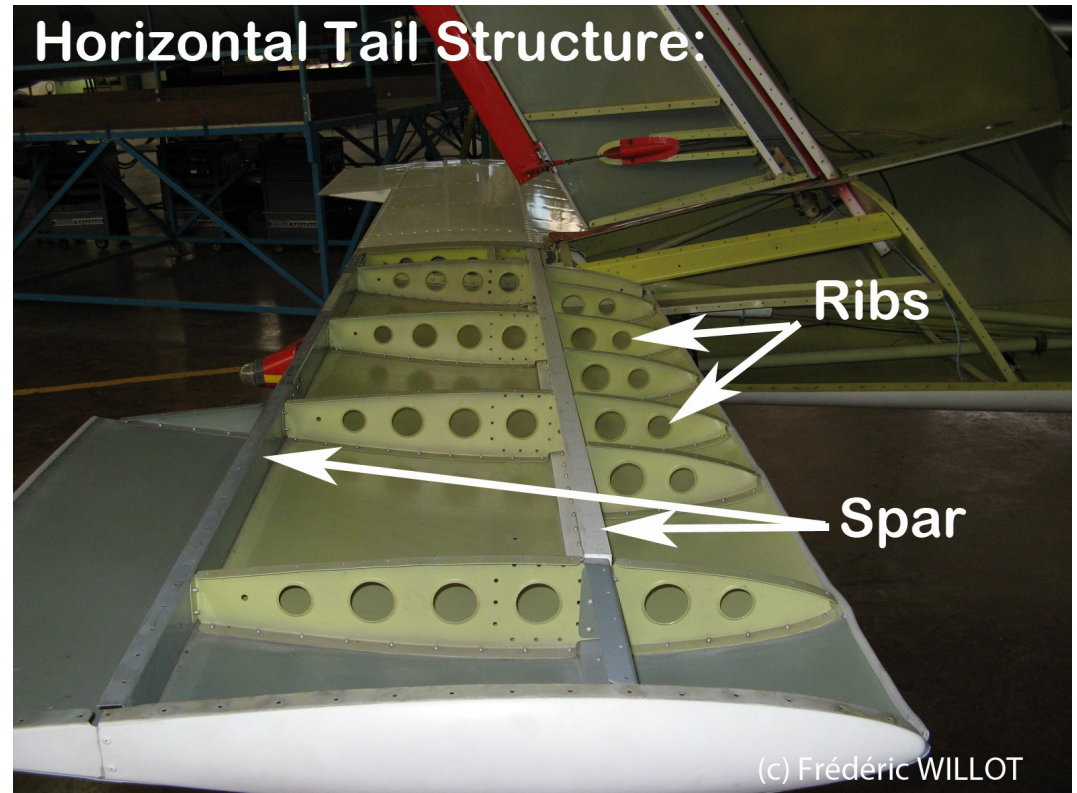

Tail designs: single fin



Low-set



Mid-set



High-set



T-tail

Original designs:



Canard



V-tail



Twin fin designs.



Aeronautical English File 05: Fuselage

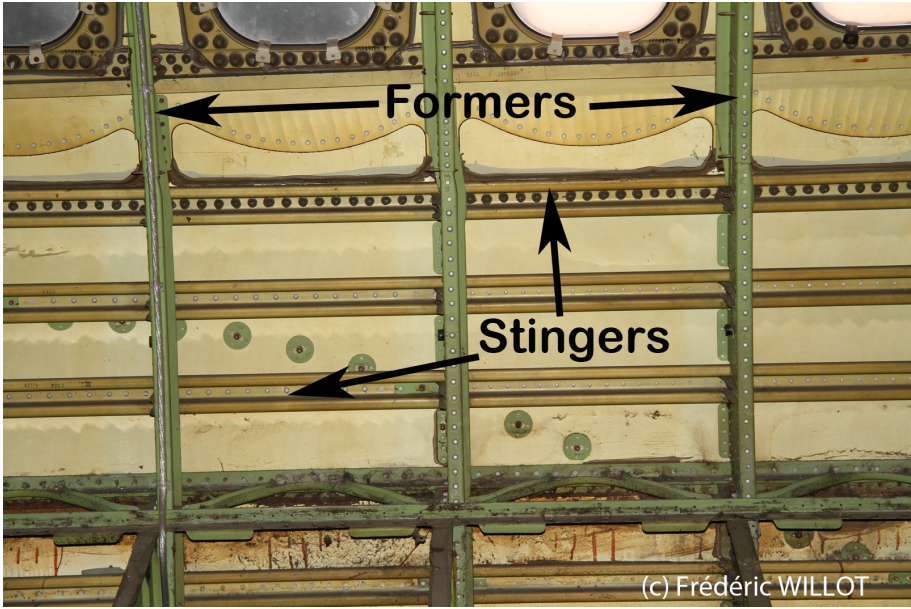
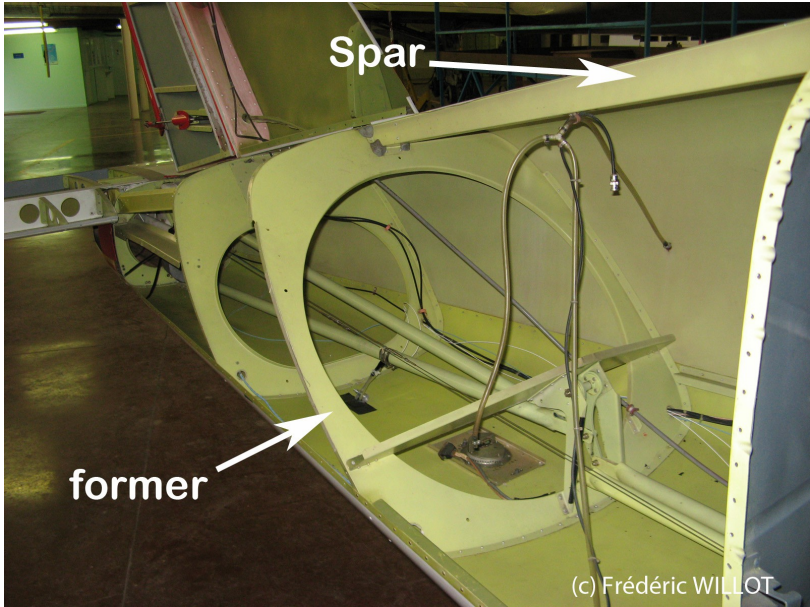

Fuselage designs :



(c) Frédéric WILLOT
Cylindrical fuselage



(c) Frédéric WILLOT
Squared fuselage



(c) Frédéric WILLOT
Twin boom fuselage



(c) Frédéric WILLOT
Airbrakes

Aeronautical English File 06: Landing gear

Undercarriage layouts:



(c) Frédéric WILLOT

Tailwheel undercarriage



(c) Frédéric WILLOT

Tricycle (nosewheel) undercarriage



(c) Frédéric WILLOT

Flying boat type of seaplane with additional floats



(c) Frédéric WILLOT

Wheel layouts:



Twin wheels nose gear of a Rafale



Single wheel nose gear of a Typhoon



Single wheel main gear of a Typhoon



6 wheels bogie of an A330



Monotracer landing gear of a Harrier fighter jet.

Aeronautical English File 07: Engines

Piston Engine:

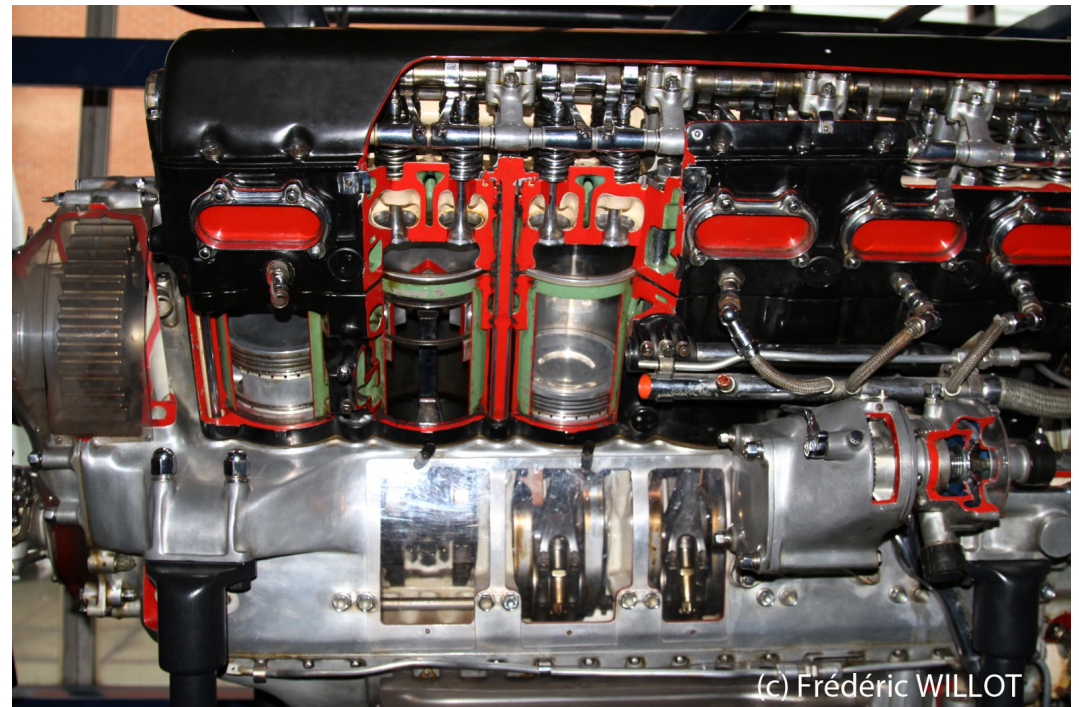
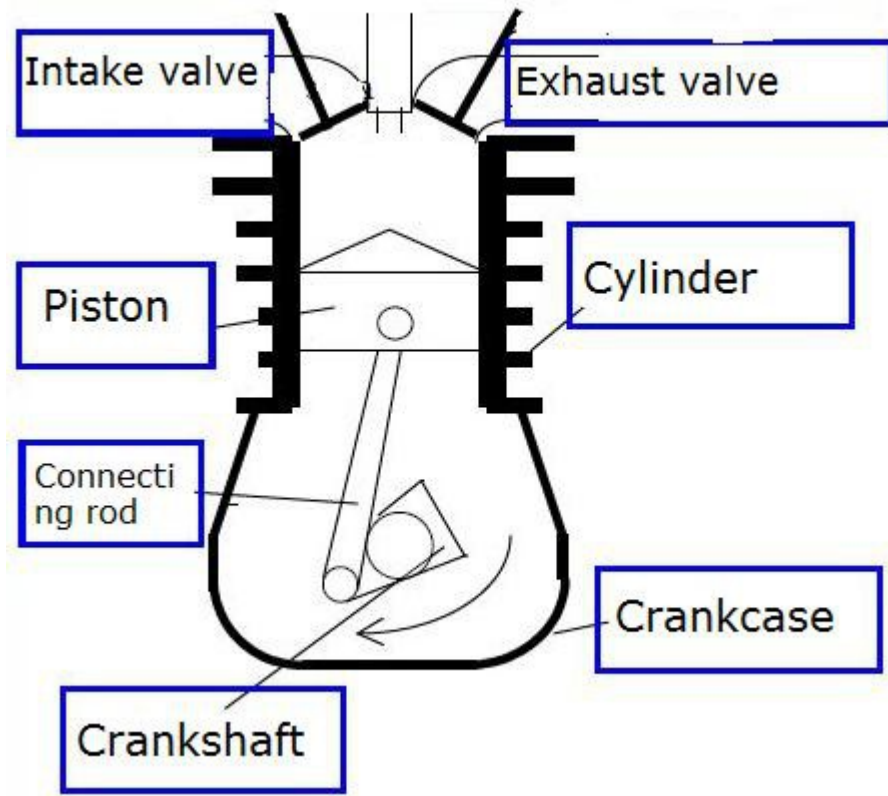

V shape d18 cylinder piston engine.

Jet Engine:

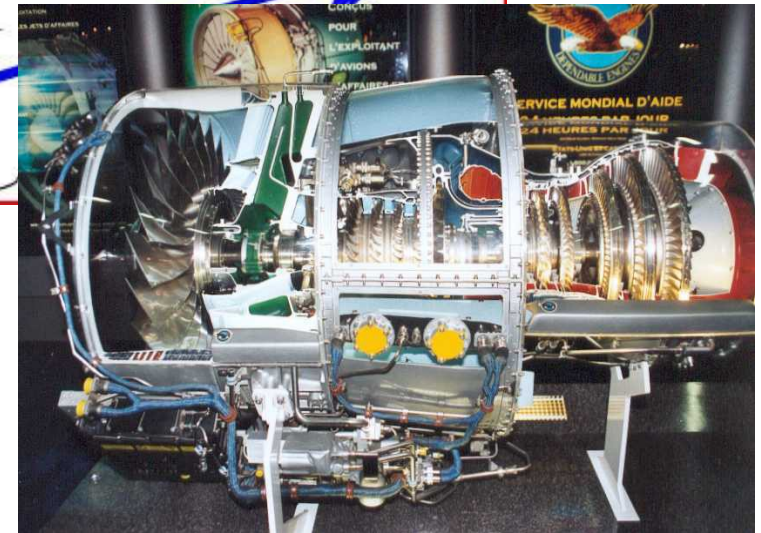
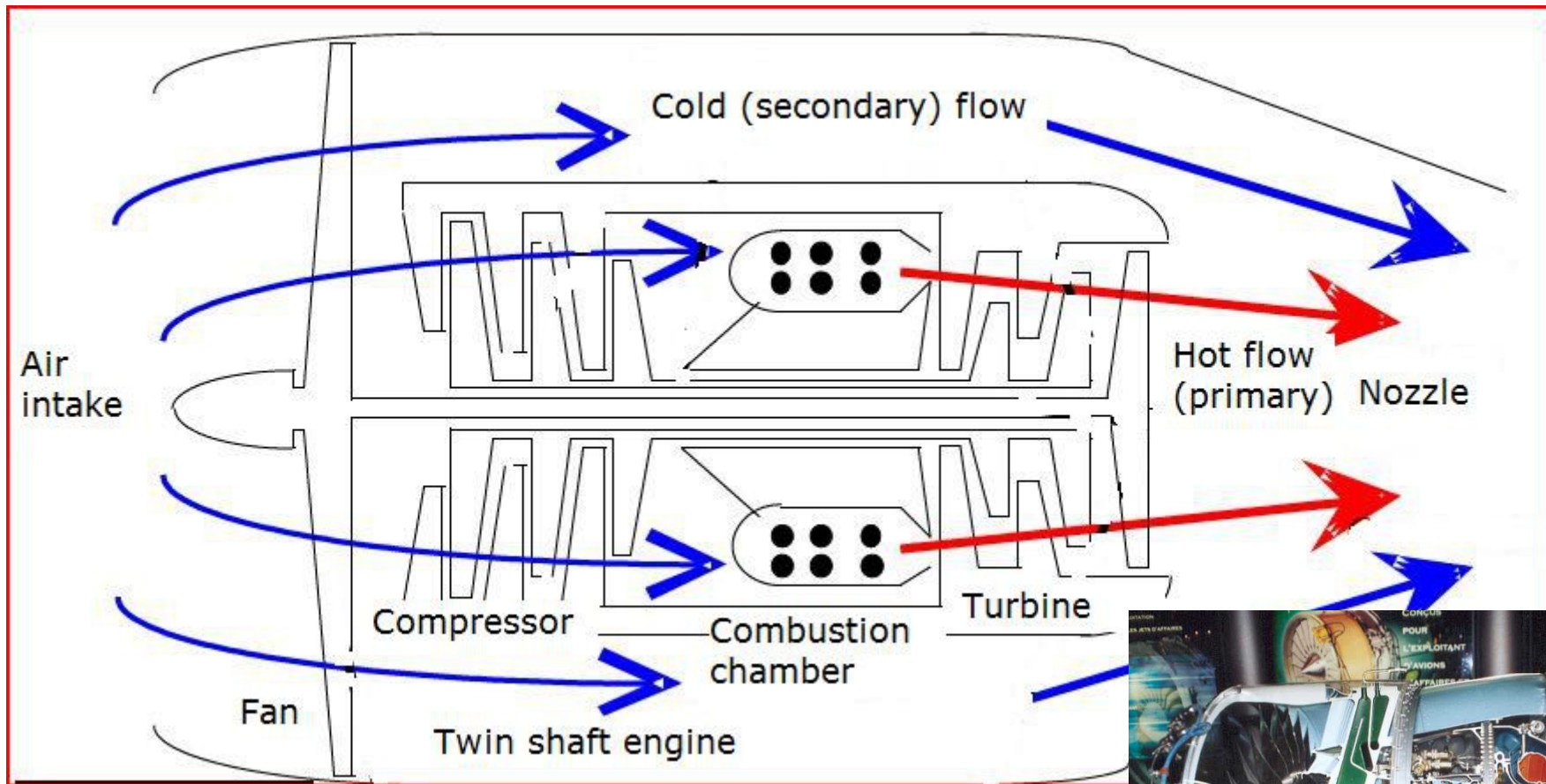

Turboprop Engine:

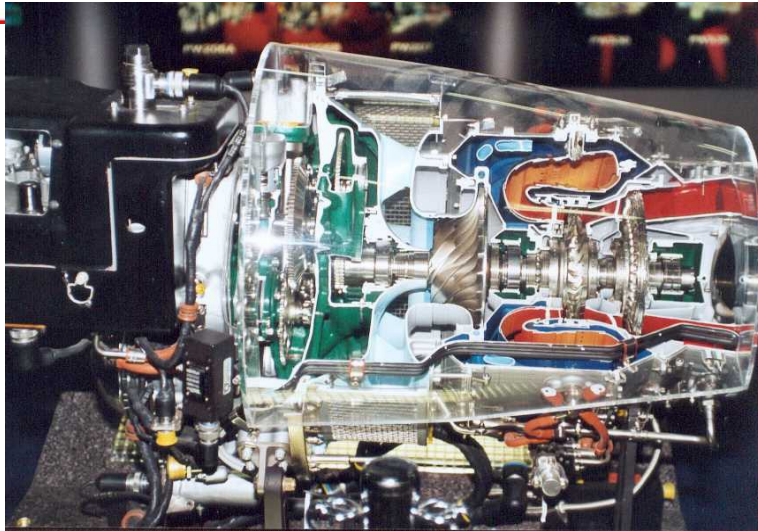
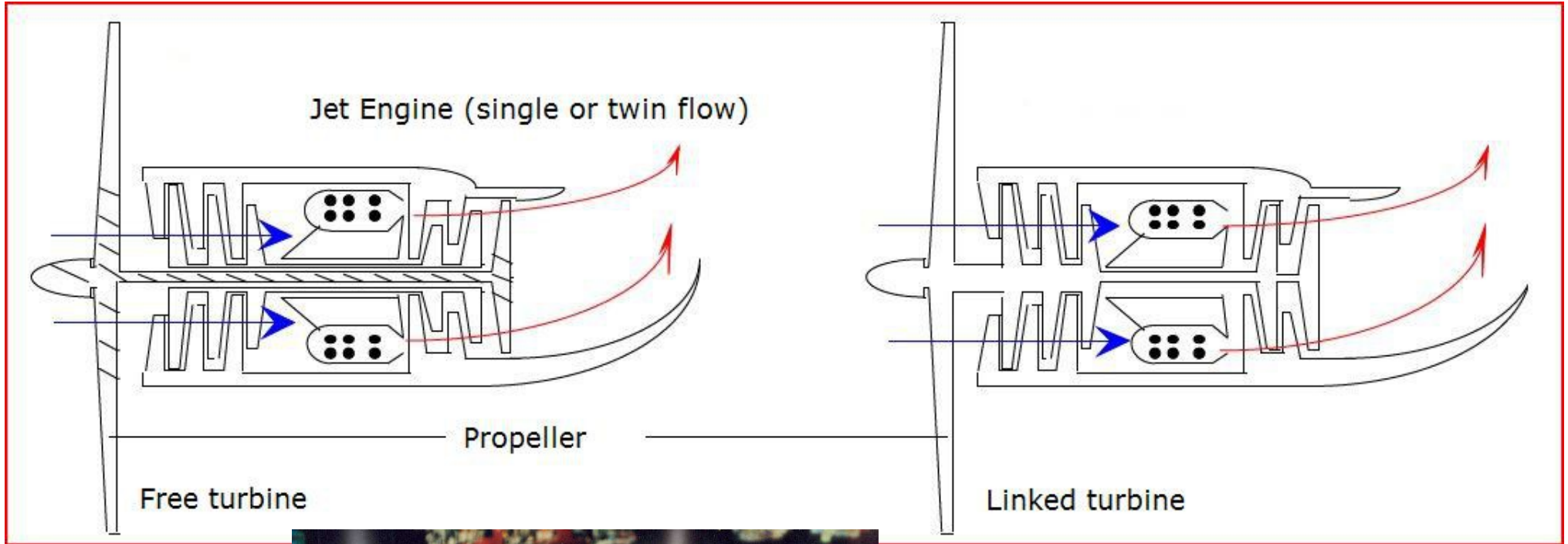

Ramjet Engine:

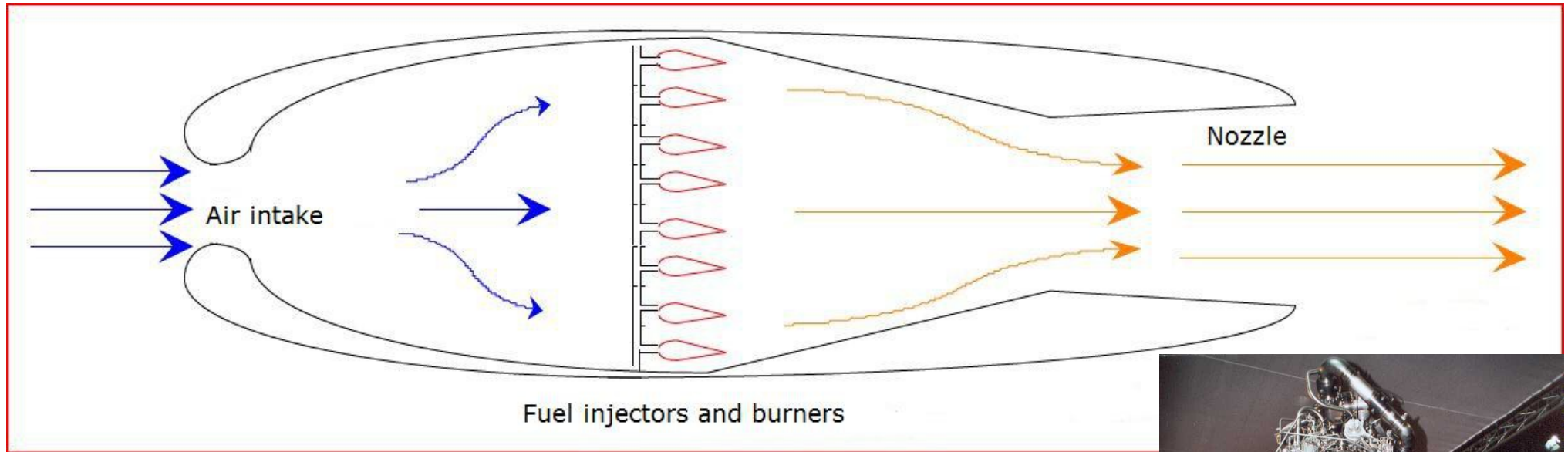

Rocket Engine:



Engines and Air Inlets Mounts:



Nose mounted engine



Inside the fuselage mounted engine



Underwing pod mounted engines



Overwing nacelle mounted engines



(c) Frédéric WILLOT
Rear podded engines



(c) Frédéric WILLOT
Buried in the wing engines



(c) Frédéric WILLOT
Ventral air inlet



(c) Frédéric WILLOT
Lateral air intakes

Aeronautical English File 08: Cockpit

Glider cockpit

Airspeed Indicator

Vertical Speed Indicator

Altimeter



(c) Frédéric WILLOT

Airbrakes lever

Magnetic Compass

Stick

Radio (COM)

Traffic Collision Avoidance System

Light Aircraft Cockpit

Airspeed Indicator Artificial Horizon Altimeter VOR indicator Tachometer RDO panel



Oil temperature and pressure indicators
Voltmeter
Ampermeter

Switches and breakers

Steering wheel

Throttle
Carburetor heater

Rudder pedals

(c) Frédéric WILLOT

Turn & Bank Indicator Heading Indicator Vertical Speed Indicator Automatic Direction finder

Airliner Cockpit



RDR altimeter
AH
Altimeter

RMI
Engine control
instruments

Throttles

Trim

(c) Frédéric WILLOT

Airspeed Indicator
Steering wheel
Machmeter
Heading Indicator

Glass Cockpit

PFD

ND



Combat Aircraft Cockpit



Clock
Flaps, AB
& gear
Ind.
ILS
Airspeed
Indicator
IFF

Stick

G-meter

Oil pressure &
temperature

AH & slip ind.
Altimeter

RMI
VSI

RDO panel

Ejection seat

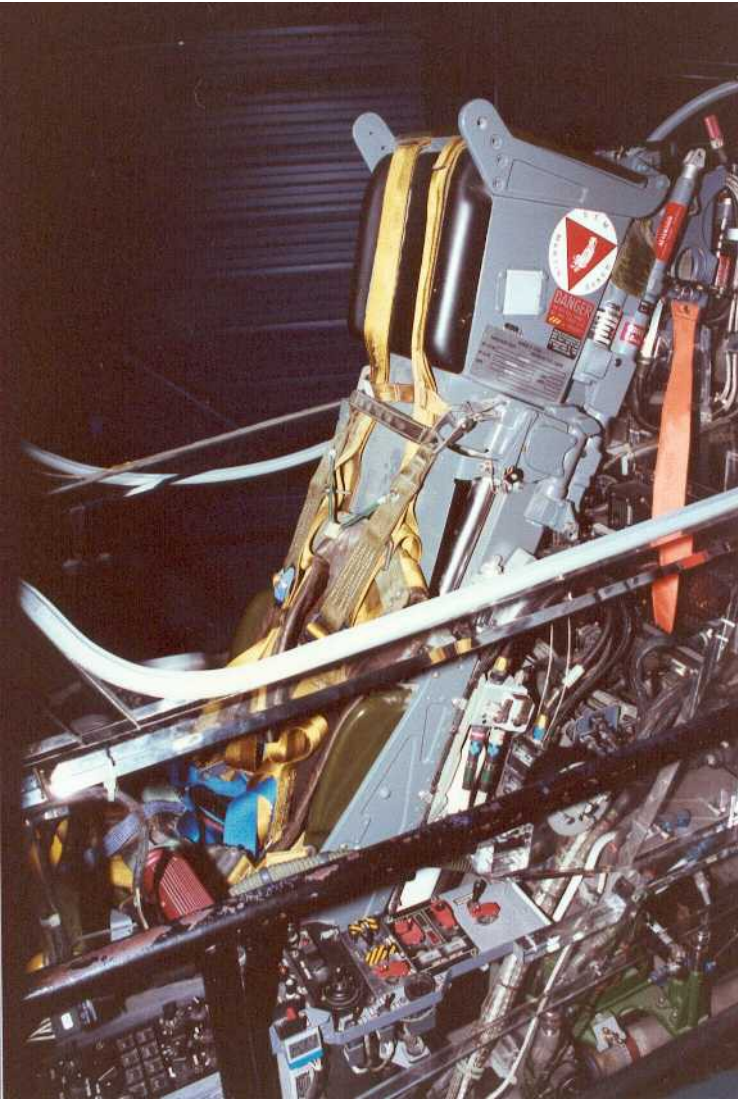

Aeronautical English File 09: Aerodynamics

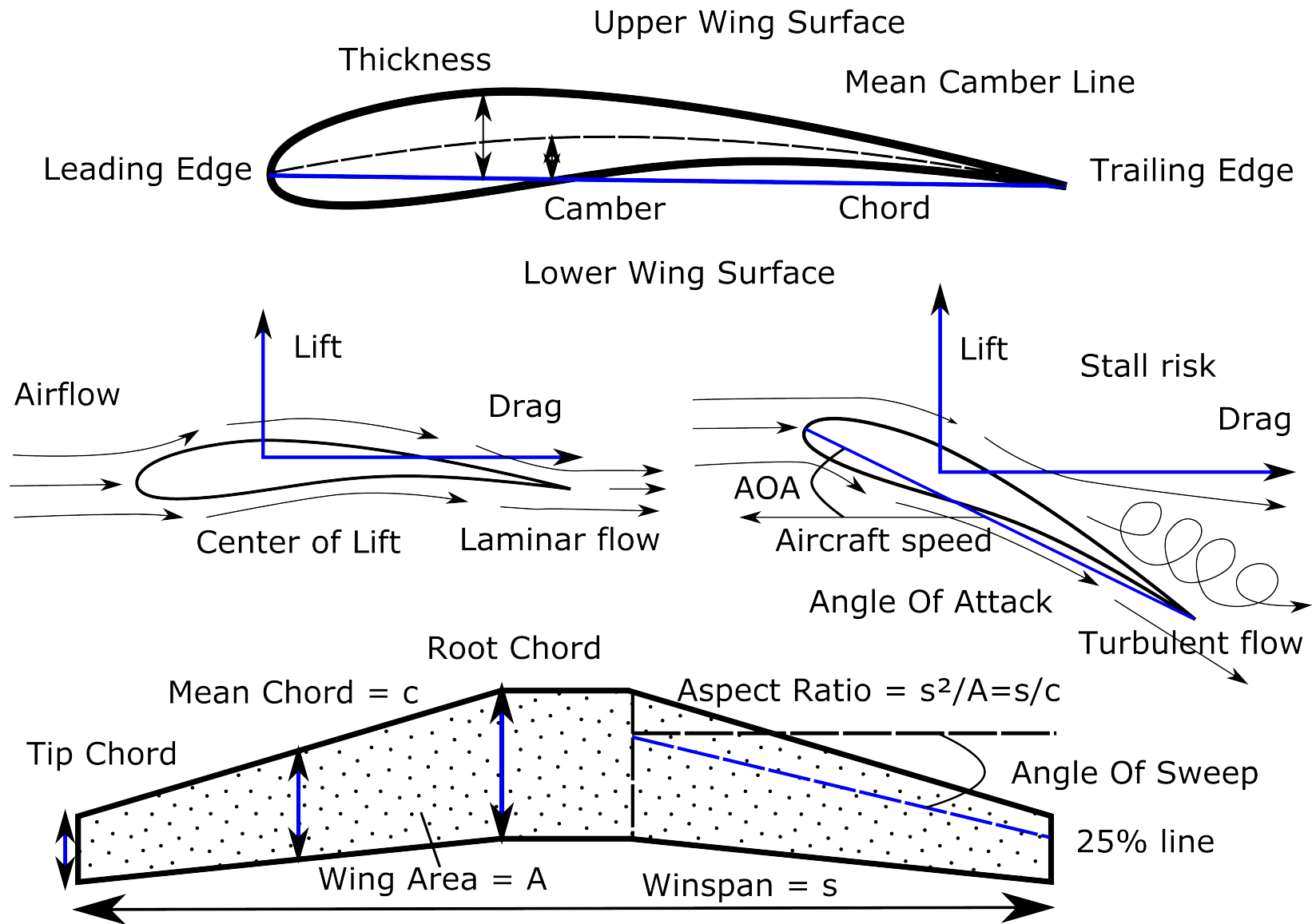

Aeronautical English File 10: Flight Mechanics

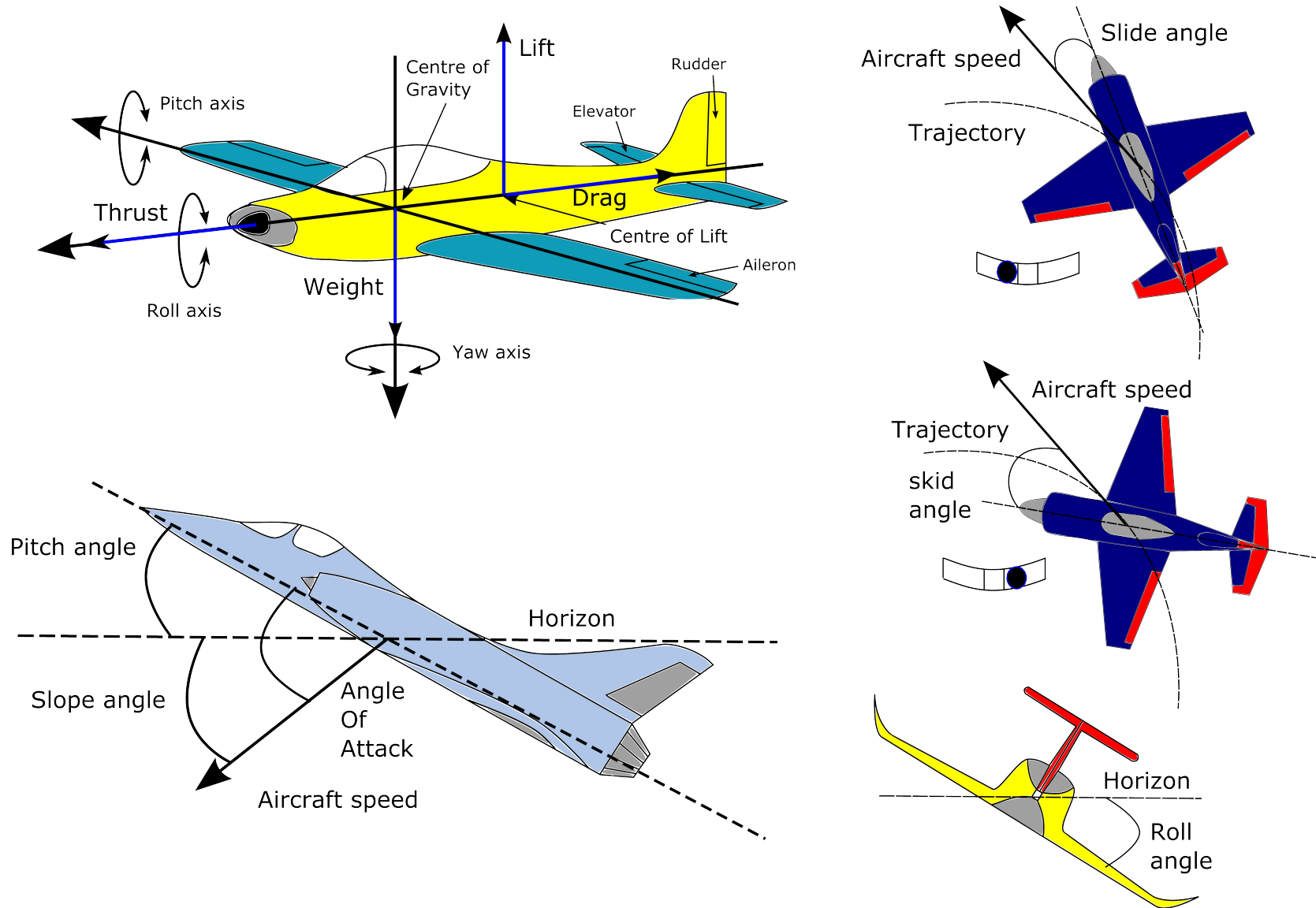

Pitch movement control

pushing the stick

pulling the stick

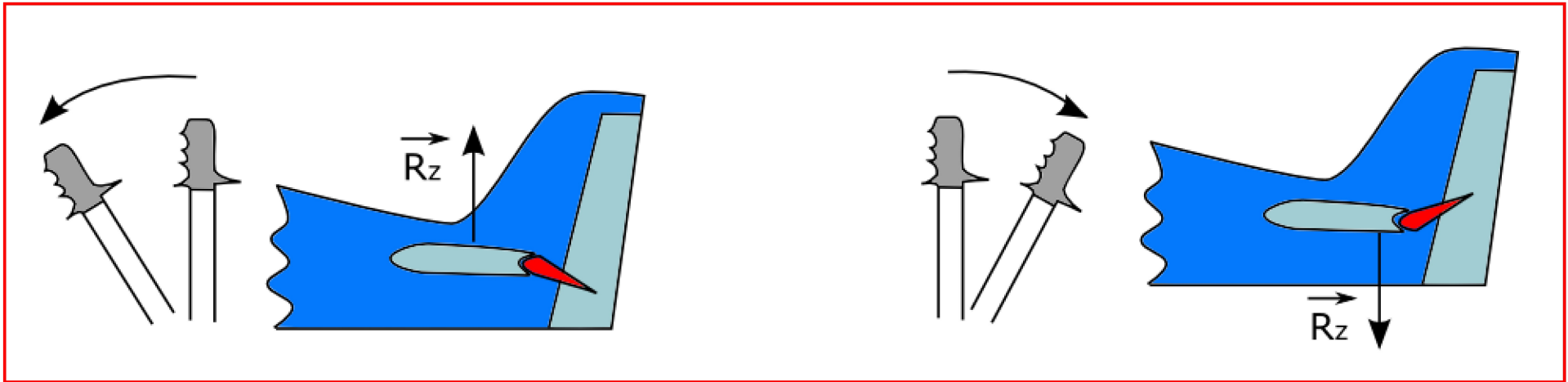

The elevators go down and the nose goes up.

The elevators go down and the nose goes up.

The elevators move in a symmetrical movement.

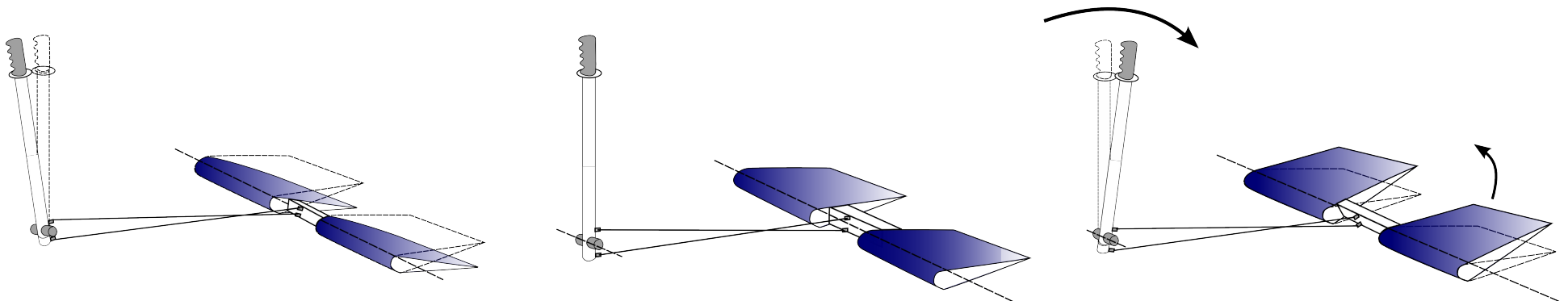

Roll movement control

Pulling the stick to the left

Pushing the stick to the right

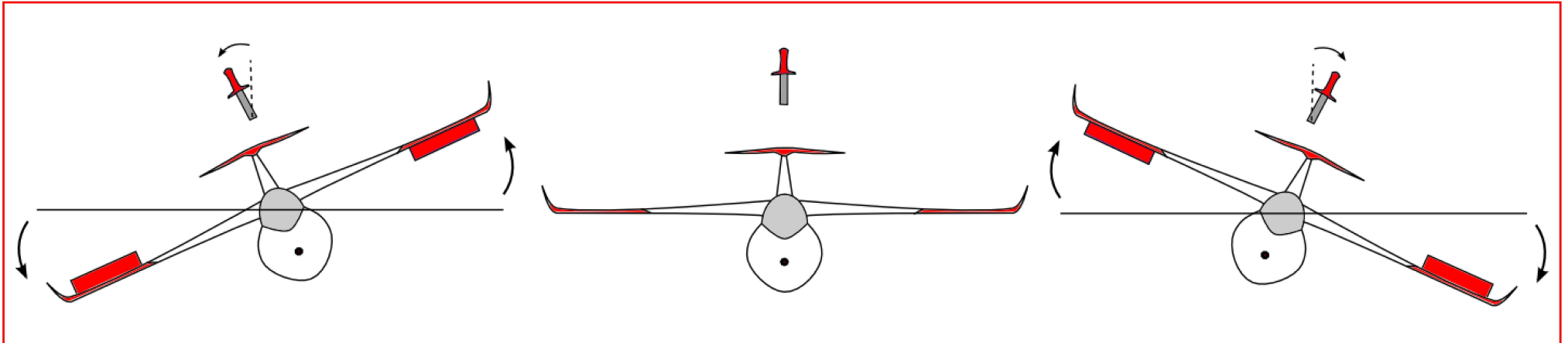

The right aileron goes up and the left aileron goes down. The plane rolls to the right.
The left aileron goes up and the right aileron goes down. The plane rolls to the left.

The ailerons move in a disymmetrical movement.

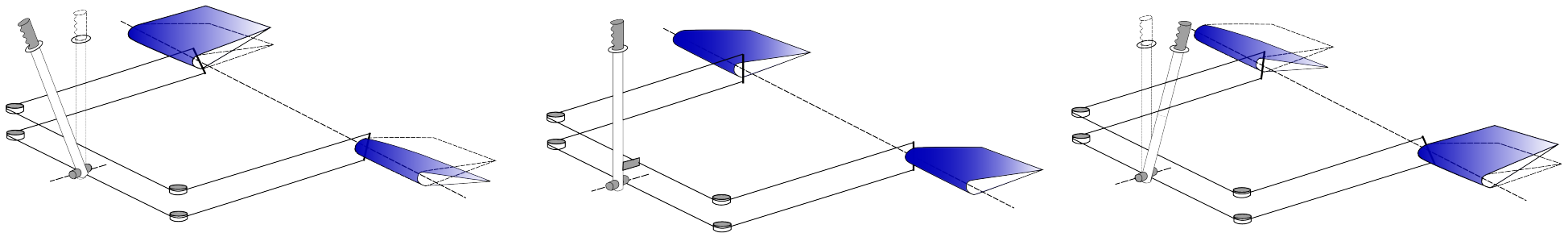

Yaw movement control

Pushing the rudder pedal to the right

Pushing the rudder pedal to the left

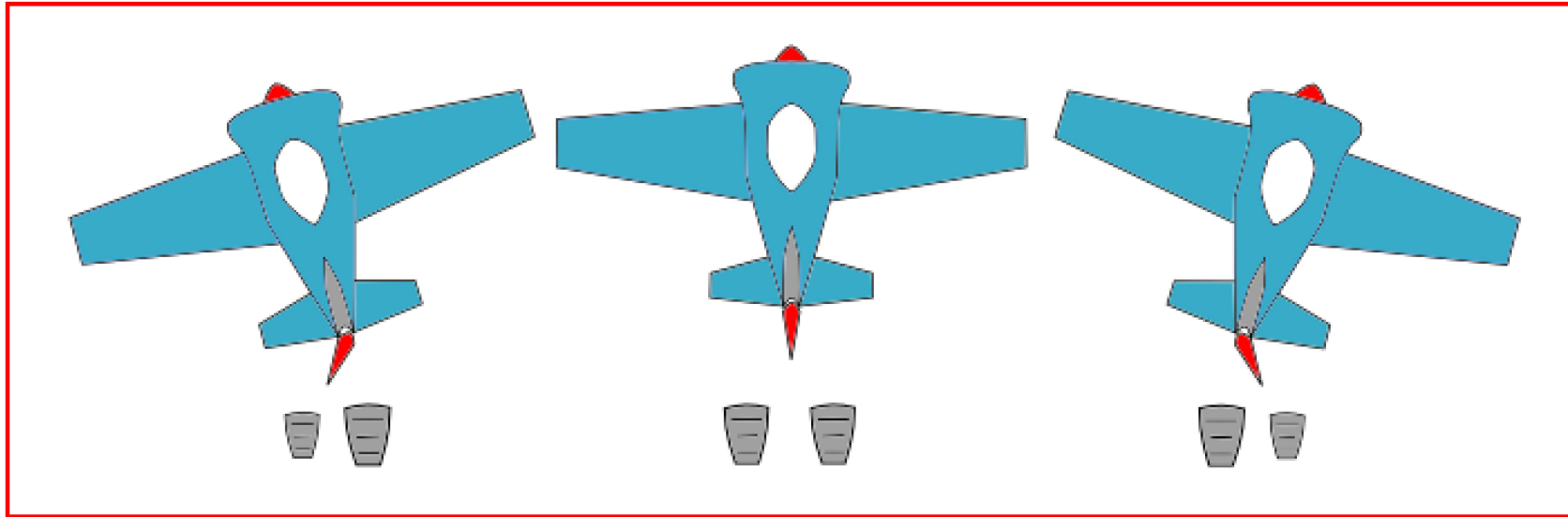

The rudder moves to the left.

The rudder moves to the right.

The rudder pedals move together in the opposite way.

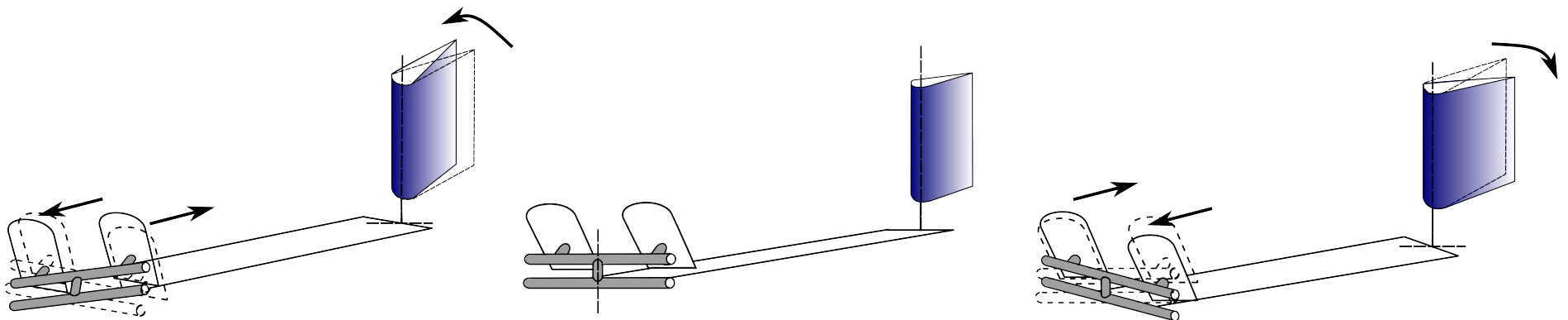

Aeronautical English File 11: Airport Infrastructure and Traffic Pattern

Airport infrastructure:

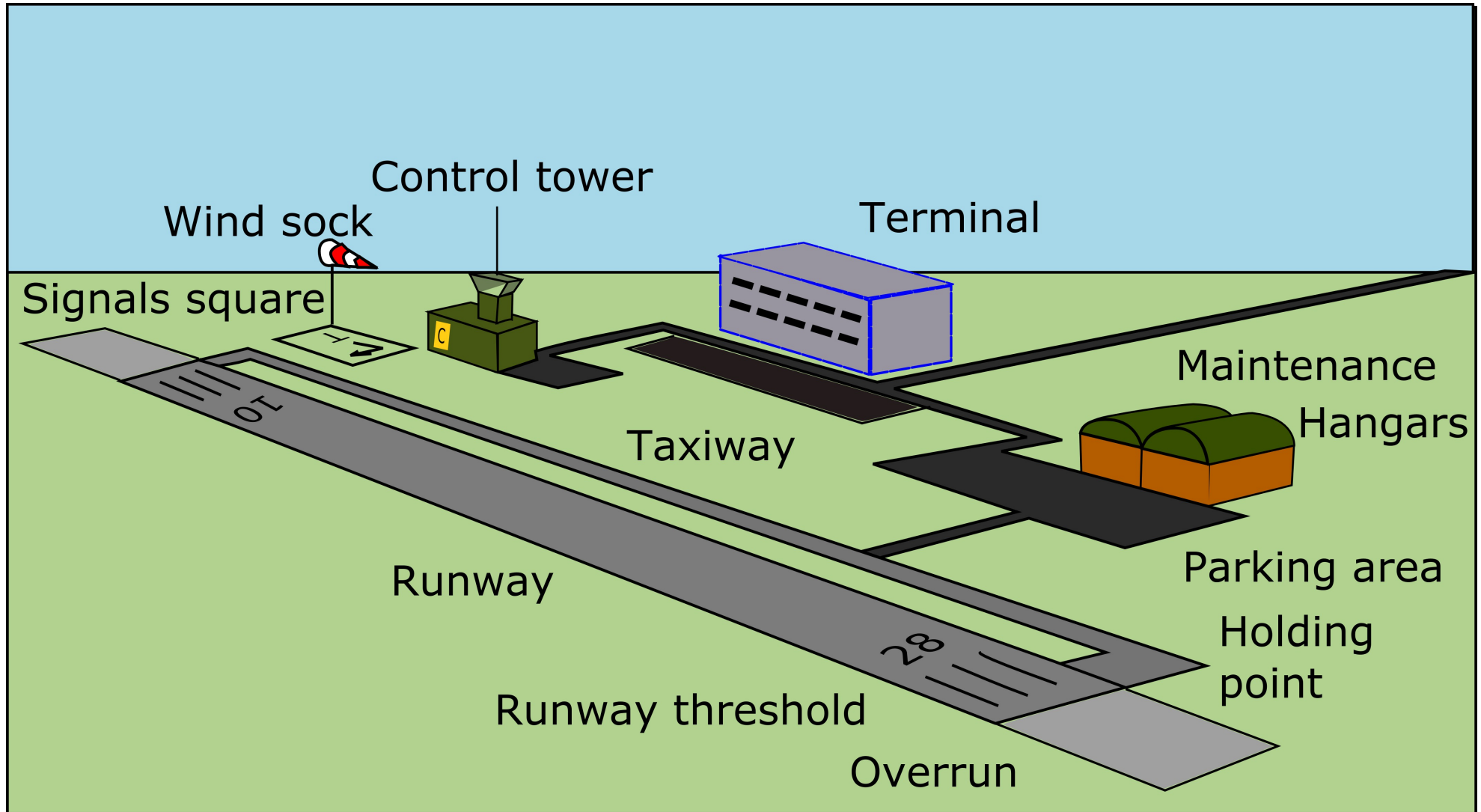

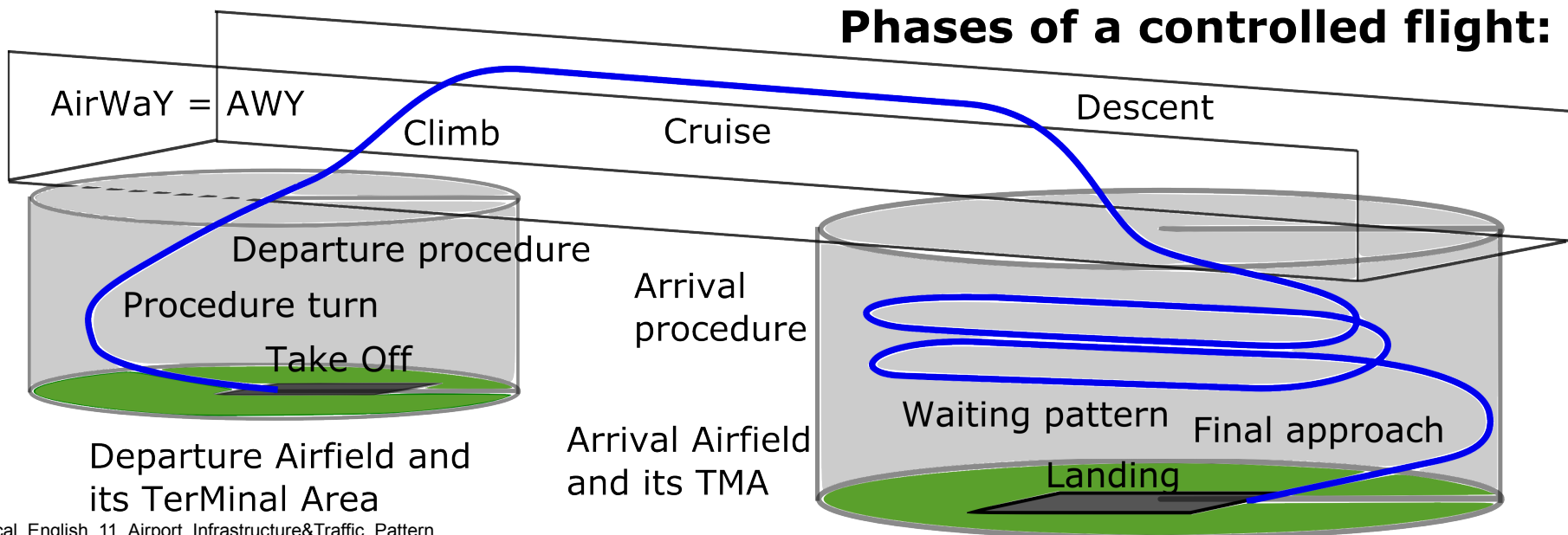
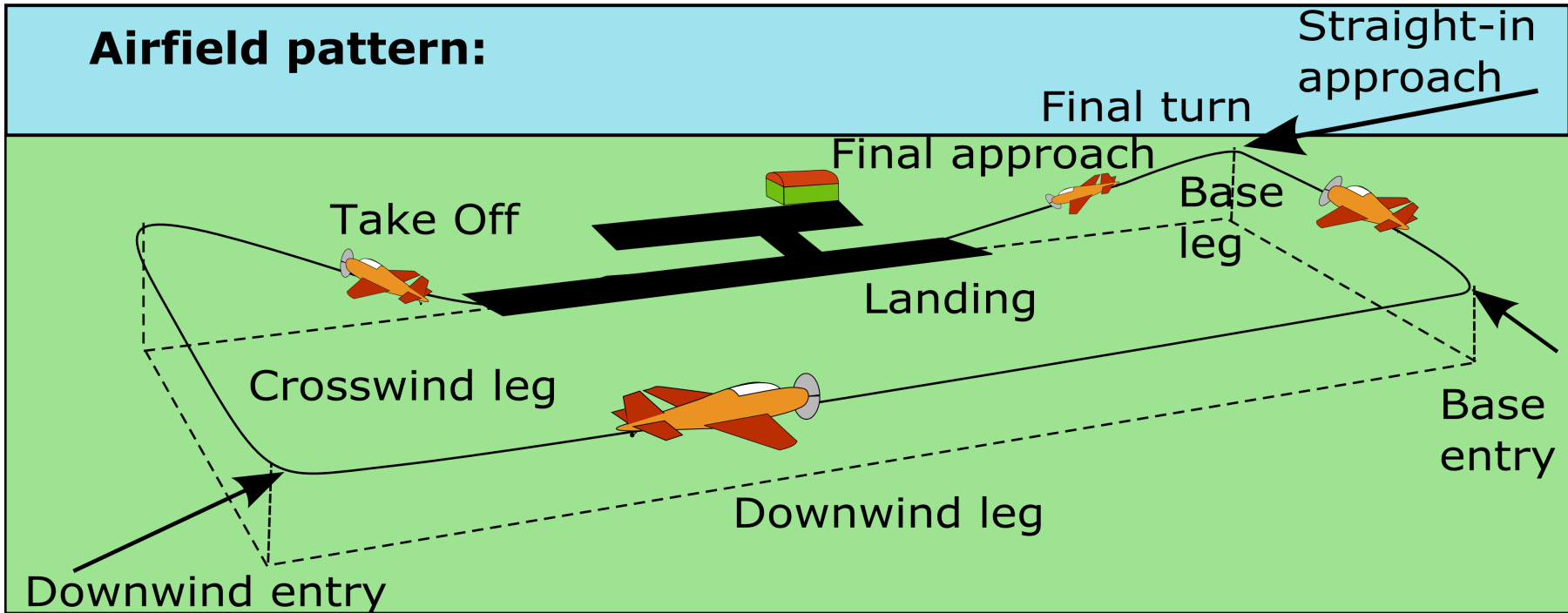

Aeronautical English File 12: Air Navigation

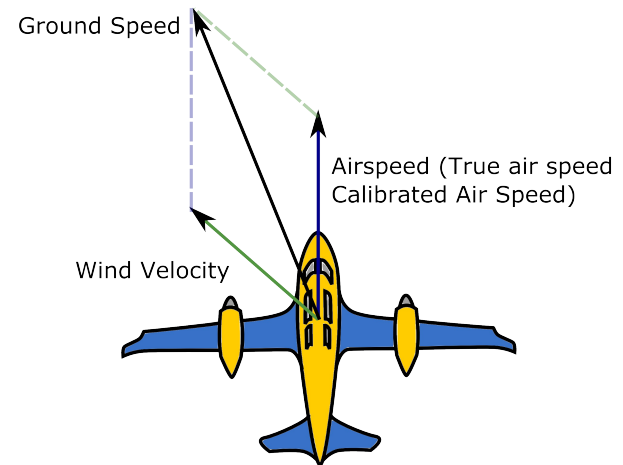
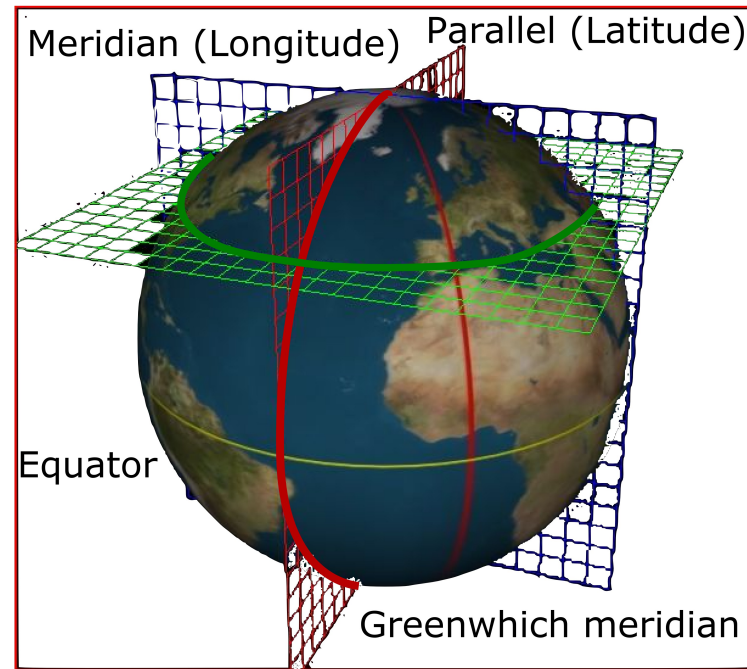
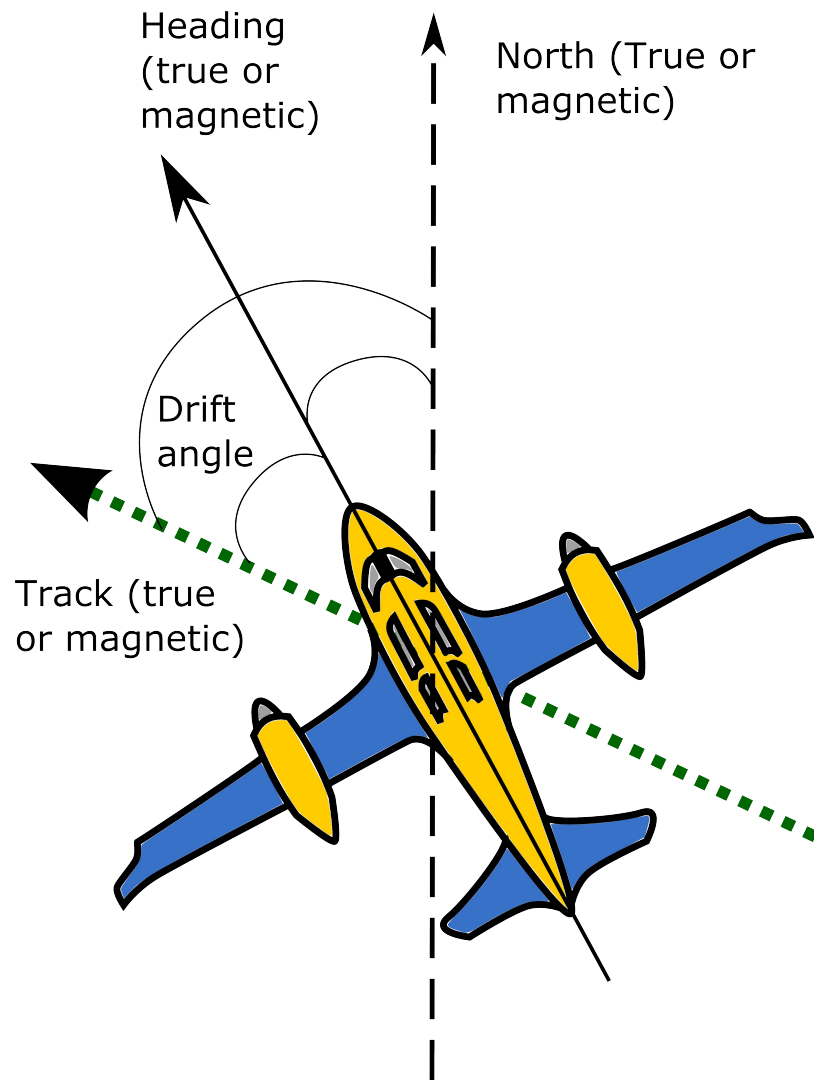

Weather map:

20Z 27 OCT 1999

Isobars, Fronts, Radar & Data

Fronts at 18Z 27

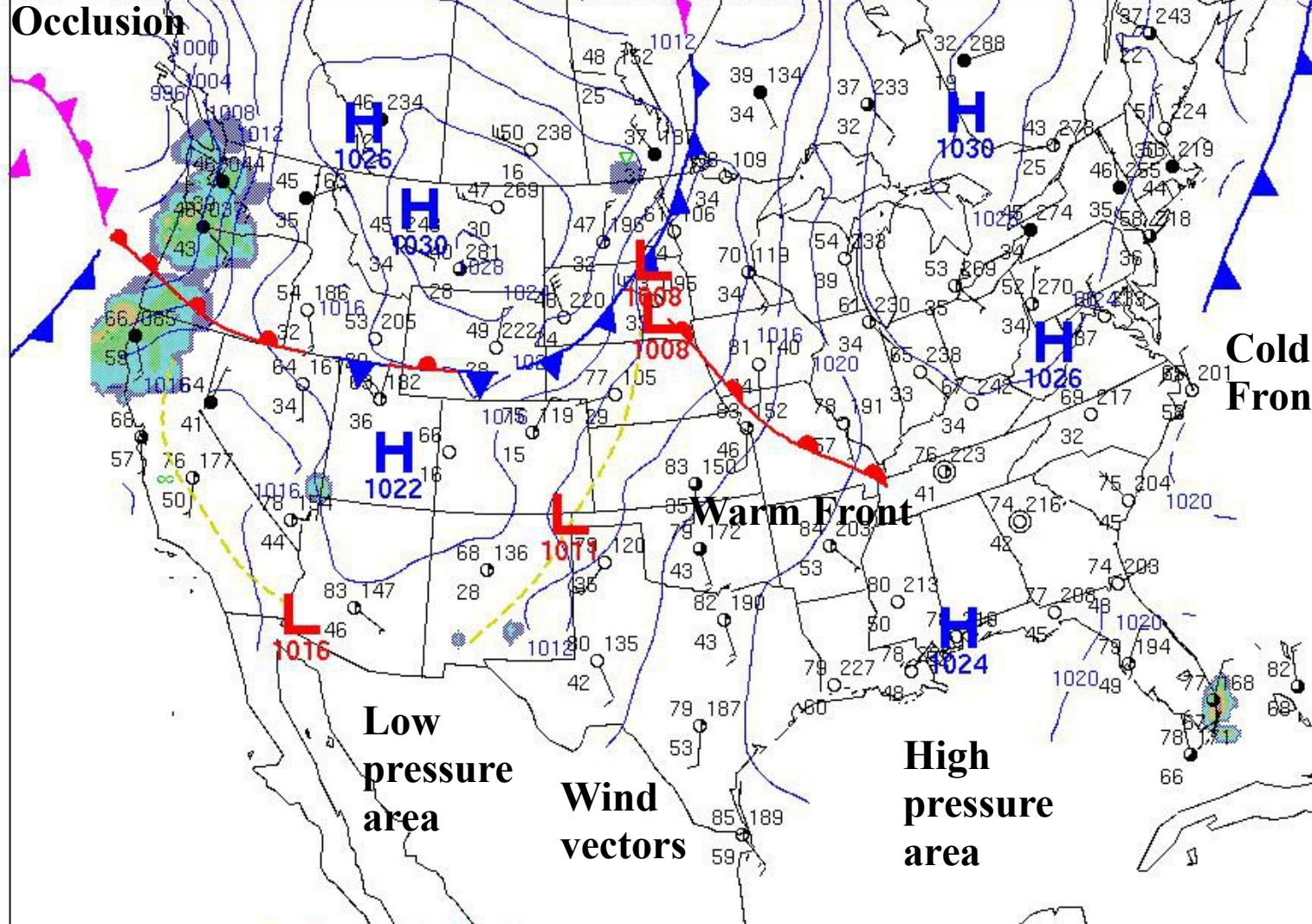

Echo Intensities: 1 2 3 4 5 6
source: www.as.yu.edu

Blue - Isobars (4 mb)

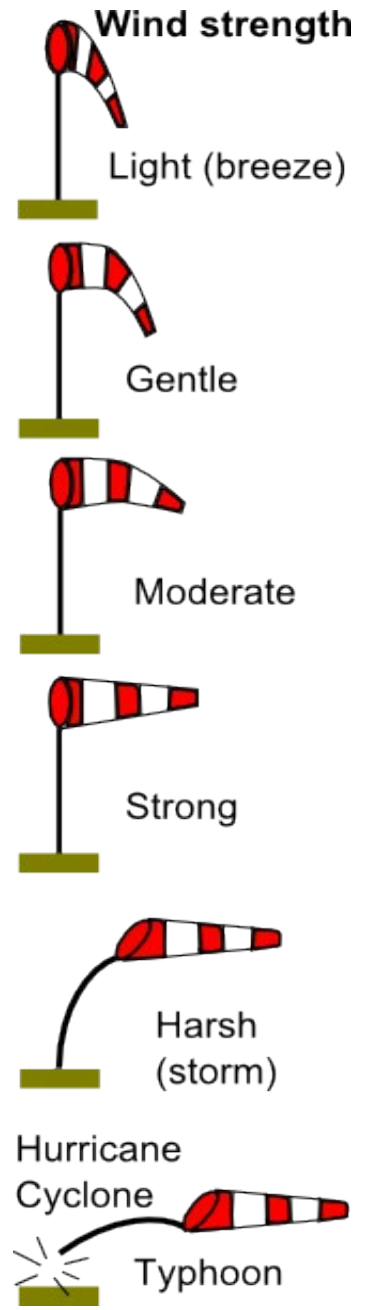

SIGLES couramment employés et leur signification anglaise et française

Sigle	Anglais	Français
ADF	Automatic Direction Finder	Radiocompas
APU	Auxiliary Power Unit	Groupe Auxiliaire de Puissance(GAP)
ATC	Air Traffic Control	contrôle de la circulation aérienne
BKN	BroKeN	fragmentés (5-7 octas)
CAT	Clear Air Turbulence	turbulence en ciel clair
CAVOK	Ceiling And Visibility OK	plafond et visibilité OK
CVR	Cockpit Voice Recorder	enregistreur de conversations de poste de pilotage
DZ	Drizzle	Bruine
EGT	Exhaust Gaz Temperature	température des gaz d'échappement
FCST	ForeCaST	prévu (temps)
FDR	Flight Data Recorder (the black box)	Enregistreur des paramètres de vol (boîte noire)
FEW	FEW	peu ou quelques (1 à 2 octas)
FG	FoG	Brouillard
FM	FroM	à partir de
FZ	FreeZing	surfondu, se congelant
GR	hail	Grêle
HZ	HaZe	brume sèche
ILS	Instrument Landing System	système d'atterrissage aux instruments
KT	KnoT	Nœud
LOC	LoCally	Localement
LYR	LaYeR	en couches
METAR	METeorologicAl Report	message d'observation régulière
NOSIG	No significant change in next two hours	Pas de changement significatif au cours des 2 heures à venir
NSC	No Significant Cloud	Pas de nuages (0 octa) (remplace SKC en 2010)
OVC	OVerCast	couvert (bouché 8 octas)
PROB	PROBably	Probablement
RA	RAin	Pluie
RPM	Révolutions Per Minute	Tours par minutes
SCT	SCaTtered	épars (3-4 octas)
SH	SHower	averse
SHSN	SHower SNow	averse de neige
SIGMET	SIGnifiant METeorology	phénomènes significatifs
SKC	SKy Clear	ciel clair (remplacé par NSC en 2010)
SN	SNow	Neige
TAF	Terminal Area Forecast	bulletin de prévision d'aérodrome
TEMPO	Temporarily	Temporairement
TEMSI		Temps Significatif
TS	ThunderStorm	Orage
UTC	Universal Time Coordinated	temps universel coordonné
VALID	Validity	Validité

Français	Anglais
aérofreins	airbrakes
Aileron	aileron
Aile	wing
aillette d'extrémité d'aile (<i>ou penne</i>)	winglet
allumage	ignition
altimètre	altimeter
Altitude	altitude
Amortir	to damp
anémomètre ou Badin	airspeed indicator
approche	approach
arrière (vers l'arrière de l'appareil)	aft
Atterrir	to land
autorisation (<i>clairance</i>)	clearance
autorisé (<i>pour une option</i>)	cleared (for something)
avertisseur de décrochage	stall warning indicator, stick shaker
avion à réaction	jet aircraft
avion à train classique	taildragger, tail-dragger, tailwheel aircraft
avion à train tricycle	nose wheel or tricycle landing gear plane
avion canard (<i>ou plan canard</i>)	canard plane
avion pressurisé	pressurized aircraft
bec (<i>de bord d'attaque</i>)	slat (<i>of the leading edge</i>) or slot
Bielle	connecting rod
bimoteur	twin-engine aircraft
bloc moteur (Groupe Moto Propulseur)	Powerplant - Engine
boîte de vitesse (ou réducteur)	gear box
bord d'attaque	leading edge
bord de fuite	trailing edge
bougie	spark plug
boulon	bolt
boussole ou compas	compass
brouillard	fog
bruine	drizzle
brûleur	burner
brume	mist
cabine (<i>ou habitacle</i>)	cabin (or cockpit)
cap	heading
carter	crankcase
cisaillement (<i>de vent</i>)	windshear
commande (<i>une</i>)	a control
commande d'aérofreins	airbrakes lever
commandes de vol	flight controls
compenser	to trim
compte-tours	tachometer
couche	layer
cylindre	Cylinder
décoller	to take off
déraper	to skid
dérive (<i>au sens d'objet</i>)	vertical fin [or tail]

Français	Anglais
dérive (<i>écart entre cap et route</i>)	Drift
diffuseur	Diffuser
dispositif [système]	Device
écoulement de l'air (<i>vent relatif</i>)	Airflow
empennage	Empennage
enregistreur de vol (<i>données</i>)	flight data recorder
équipage	Crew
essuie-glace	windshield (or windscreen) wiper
facteur de charge	load factor
feu tournant, feu anticollision, strobe	rotating light, beacon light, rotating beacon
flotteurs	float
fuselage	fuselage
glisser	to slip - to slide
gouverne de profondeur	elevator
habitacle	cockpit
hauteur	height
hélice	propeller
hélice à vitesse constante	constant speed propeller
hydravion à coque	flying boat
hydravion à flotteurs	seaplane
indicateur de virage (bille-aiguille)	turn and slip indicator (turn coordinator)
Informer le contrôle aérien	to advise ATC (Air Traffic Control)
inverser (la poussée)	to reverse (thrust)
inverseur de poussée	reverser or thrust reverser
lacet	yaw
levier	lever
lisse [dans la structure de l'aile]	stringer
longeron	spar
manche à air	wind sock, wind cone
manche à balai – [volant]	stick – control column – [control wheel]
moteur	engine
mouvement	motion
nervure	rib
nez	nose
nœud	knot
nuage	cloud
orifice (ou entrée) d'admission	inlet
(<i>pédale de</i>) palonnier	rudder pedal
palonnier(s) – gouverne de direction	rudder
pare-brise	windshield (or windscreen)
partie d'un avion	part of an airplane
patins ou skis	skids
phare de roulage	taxi light
pieds par minute	ft/min (feet/minute)
pilote automatique	the autopilot, the automatic pilot (AP)
piste (<i>d'aéroport</i>)	runway
plafond	ceiling
plan fixe horizontal	horizontal stabilizer
portance	lift
Poussée	thrust

Français	Anglais
pousser sur le manche	to push the stick forward
prendre un cap	to set a heading
profil	airfoil
propulser	to propel
queue	tail
radio compas	automatic direction finder (ADF)
rafale	gust
réacteur	reactor, jet engine
refroidissement par air	air cooling
réservoir (<i>d'essence</i>)	(<i>fuel</i>) tank
revêtement (<i>d'aile</i>)	skin
rivet	rivet
roulette de nez	nose wheel
roulette de queue	tail wheel
roulis	roll
route magnétique	magnetic road
s'aligner	to line up
saumon [d'aile]	wing tip
scruter le ciel	to scan the sky
se déplacer (<i>au sol</i>)	to taxi
sortir le train	to extend the gear
soufflante (conduit de)	(duct) fan
soupape (d'admission, d'échappement)	(intake, exhaust) valve
système de commandes de vol électrique	a fly-by-wire (FBW) flight-control system
tableau de bord	instrument panel
tangage	pitch
tôle ou feuille (<i>d'aluminium</i>)	(<i>aluminium</i>) sheet
tour de contrôle	airport control tower
tr/min (<i>tour par minute</i>)	rpm (round per minute)
train (<i>d'atterrissage</i>) fixe	fixed gear
train (<i>d'atterrissage</i>) principal	main (<i>landing</i>) gear
train (<i>d'atterrissage</i>) tricycle	tricycle landing gear
train d'atterrissage	landing gear – [undercarriage]
train rentrant	retractable gear
traînée	drag
traînée de condensation	contrails
transpondeur	transponder
tuyère	nozzle
variomètre	vertical speed indicator
vent arrière	tailwind
vent de face (<i>ou vent contraire</i>)	headwind
vent de travers	crosswind
verrière	canopy
vilebrequin	crankshaft
vis	screw
vitesse de croisière	cruising speed
volant	Steering wheel
volet (<i>hypersustentateur</i>)	flap
volet compensateur	trim tab
volet à fente	slotted wing flap (or slot flap)

Liste de vocabulaire aéronautique exigible

Anglais → Français

Anglais	Français
a control	commande (une)
a fly-by-wire (FBW) flight-control system	système de commandes de vol électrique
aft	arrière (vers l'arrière de l'appareil)
aileron	aileron
air cooling	refroidissement par air
airbrakes	aérofreins
airbrakes lever	commande d'aérofreins
airflow	écoulement de l'air (vent relatif)
airfoil	profil
airport control tower	tour de contrôle
airspeed indicator	anémomètre ou Badin
altimeter	altimètre
altitude	altitude
approach	approche
automatic direction finder (ADF)	radio compas
bolt	boulon
burner	brûleur
cabin (or cockpit)	cabine (ou habitacle)
canard plane	avion canard (<i>ou plan canard</i>)
canopy	verrière
ceiling	plafond
clearance	autorisation (clairance)
cleared (for something)	autorisé (<i>pour une option</i>)
cloud	nuage
cockpit	habitacle
compass	boussole ou compas
connecting rod	bielle
constant speed propeller	hélice à vitesse constante
contrails	traînée de condensation
crankcase	carter
crankshaft	vilebrequin
crew	équipage
crosswind	vent de travers
cruising speed	vitesse de croisière
cylinder	cylindre
device	dispositif [système]
diffuser	diffuseur
drag	traînée
drift	dérive (<i>au sens d'écart entre cap et route</i>)
drizzle	bruine
elevator	gouverne de profondeur
empennage	empennage
engine	moteur
(duct) fan	soufflante (conduit de)
fixed gear	train (<i>d'atterrissage</i>) fixe
flap	volet (<i>hypersustentateur</i>)
flight controls	commandes de vol
flight data recorder	enregistreur de vol (<i>données</i>)

Anglais	Français
float	flotteurs
flying boat	hydravion à coque
fog	brouillard
ft/min (feet/minute)	pieds par minute
fuselage	fuselage
gear box	boîte de vitesse (ou réducteur)
gust	rafale
heading	cap
headwind	vent de face (ou vent contraire)
height	hauteur
horizontal stabilizer	plan fixe horizontal
ignition	allumage
inlet	orifice (ou entrée) d'admission
instrument panel	tableau de bord
jet aircraft	avion à réaction
knot	nœud
landing gear – [undercarriage]	train d'atterrissage
layer	couche
leading edge	bord d'attaque
lever	levier
lift	portance
load factor	facteur de charge
magnetic road	route magnétique
main (<i>landing</i>) gear	train (<i>d'atterrissage</i>) principal
mist	brume
motion	mouvement
nose	nez
nose wheel	roulette de nez
nose wheel or tricycle landing gear plane	avion à train tricycle
nozzle	tuyère
part of an airplane	partie d'un avion
pitch	tangage
power plant	bloc moteur (Groupe Moto Propulseur)
pressurized aircraft	avion pressurisé
propeller	hélice
reactor, jet engine	réacteur
retractable gear	train rentrant
reverser or thrust reverser	inverseur de poussée
rib	nervure
rivet	rivet
roll	roulis
rotating light, beacon light, rotating beacon	feu tournant, feu anticollision, strobe
rpm (round per minute)	tr/min (tour par minute)
rudder	palonnier(s) – (<i>gouverne de direction</i>)
rudder pedals (<i>rudder bar</i>)	(<i>pédale ou commande de</i>) palonniers
runway	piste (<i>d'aéroport</i>)
screw	vis
seaplane	hydravion à flotteurs
sheet (<i>aluminium sheet</i>)	tôle ou feuille (<i>d'aluminium</i>)
skids	patins ou skis

Anglais	Français
skin	revêtement (<i>d'aile</i>)
slat (<i>of the leading edge</i>)	bec (<i>de bord d'attaque</i>)
slotted wing flap (or slot flap)	volet à fente
spark plug	bougie
spar	longeron
stall warning indicator, stick shaker	avertisseur de décrochage
stick – control column – [control wheel]	manche à balai – [volant]
stringer	lisse [dans la structure de l'aile]
tachometer	compte-tours
tail	queue
tail wheel	roulette de queue
taildragger, tail-dragger, tailwheel aircraft	avion à train classique
tailwind	vent arrière
(<i>fuel</i>) tank	réservoir (<i>d'essence</i>)
taxi light	phare de roulage
the autopilot, the automatic pilot (AP)	pilote automatique
thrust	poussée
to advise ATC (Air Traffic Control)	Informer le contrôle aérien
to damp	amortir
to extend the gear	sortir le train
to land	atterrir
to line up	s'aligner
to propel	propulser
to push the stick forward	pousser sur le manche
to reverse (thrust)	inverser (la poussée)
to scan the sky	scruter le ciel
to set a heading	prendre un cap
to skid	déraper
to slip / to slide	glisser
to take off	décoller
to taxi	se déplacer (<i>au sol</i>)
to trim	compenser
trailing edge	bord de fuite
transponder	transpondeur
tricycle landing gear	train (<i>d'atterrissage</i>) tricycle
trim tab	volet compensateur
turn and slip indicator (turn coordinator)	indicateur de virage (bille-aiguille)
twin-engine aircraft	bimoteur
(intake, exhaust) valve	soupape (d'admission, d'échappement)
vertical fin [or tail]	dérive (au sens d'objet)
vertical speed indicator	variomètre
wind sock, wind cone	manche à air
windshear	cisaillement (<i>de vent</i>)
windshield (or windscreen)	pare-brise
windshield (or windscreen) wiper	essuie-glace
winglet	aillette d'extrémité d'aile (<i>ou penne</i>)
wing	aile
wing tip	saumon [d'aile]
yaw	lacet